

2024 跨境电商玩具产品侵权预警报告 (1-6 月)

深圳市玩具行业协会



2024 年 7 月

目录

1. 水雾珠玩具 AQUABEADS	3
1.1 产品介绍---水雾珠玩具.....	3
1.2 水雾珠玩具---知识产权信息.....	3
2. 拳击反射球 Boxing Reflex Ball	5
2.1 产品介绍---拳击反射球 Boxing Reflex Ball	5
2.2 拳击反射球侵权排查--知识产权信息	6
3. 水上充气艇 inflatable object	8
3.1 产品信息--水上充气艇 inflatable object	8
3.2 水上充气艇 inflatable object--知识产权信息	9
4. Fin Fun 美人鱼尾巴	12
4.1.产品介绍---Fin Fun 美人鱼尾巴.....	12
4.2 Fin Fun 美人鱼尾巴---知识产权信息.....	13
5. Building block toy 积木类拼装玩具.....	16
5.1 产品介绍---积木类拼装玩具.....	16
5.2 积木类拼装玩具---知识产权信息.....	17
6. 吸盘旋转玩具 Suction Cup Spinner Toys	23
6.1 产品介绍---Suction Cup Spinner Toys	23
6.2 吸盘旋转玩具---知识产权信息	23
7. Barbie 芭比玩偶.....	26
7.1 产品介绍--Barbie 芭比.....	26
7.2 Barbie 芭比玩偶---知识产权信息	27
8. 可重复使用水球---Dongguan Saienchuangke Technology Co., Ltd.	29
8.1 产品介绍--可重复使用水球	29
8.2 可重复使用水球---知识产权信息	30
9. 插画作品涉及到的知识产权侵权风险	32
9.1 作品信息--Elizabeth Mazur 马祖尔版权画	32
9.2 作品信息--Joel robinson 涂鸦插画.....	34
9.3 作品信息--Dona Gelsinger 圣诞冬日系列画作.....	35
9.4 MOLANG 萌浪兔版权商标维权	38
10. 亚马逊等跨境电商平台临时禁止令所关注的一些玩具相关产品专利信息	39

1、水雾珠玩具 AQUABEADS

1.1 产品介绍---水雾珠玩具

Aquabeads 水雾魔法珠玩具是水活性珠，摆成想要的图形后，喷上水就会自动粘合成型，产品创意有趣，深受孩子们的喜欢。



1.2 水雾珠玩具----知识产权信息

2024年1月维权的是 Aquabeads 文字商标和图形商标，都注册在 28 类户外与玩具大类。

<h1>AQUABEADS</h1>	
Wordmark AQUABEADS	Wordmark AQUABEADS
Status LIVE REGISTERED	Status LIVE REGISTERED
Goods & services IC 028: Toys, namely, children's multiple activity toys consisting of...	Goods & services IC 028: Toys, namely, children's multiple activity toys consisting of...
Class 028	Class 028
Serial 79110885	Serial 88040599
Owners EPOCH COMPANY LTD. (CORPORATION; JAPAN)	Owners EPOCH COMPANY, LTD. (CORPORATION; JAPAN)

还涉及两个版权作品，以下是版权登记号，具体版权内容暂没有公开

<i>Deluxe Studio Template.</i>
Type of Work: Visual Material
Registration Number / Date: VA0002329186 / 2022-10-03
Application Title: Deluxe Studio Template.
Title: Deluxe Studio Template.
Description: Print material, 6 p.
Series: Aquabeads
Copyright Claimant: EPOCH COMPANY, LTD. Address: 2-2, 2-Chome, Komagata, Taito-ku, Tokyo, 111-8618, Japan.
Date of Creation: 2016
Date of Publication: 2016-12-21
Nation of First Publication: United States
Authorship on Application: EPOCH COMPANY, LTD., employer for hire; Domicile: Japan. Authorship: 2-D artwork.
Copyright Note: Basis for Registration: A Unit of Publication, which extends to only each individual copyrightable work in the UOP. 17 USC 410(a) and 37 CFR 202.3(b)(4)(i)(A).
Names: EPOCH COMPANY, LTD.
<i>Beginners Studio Template.</i>
Type of Work: Visual Material
Registration Number / Date: VA0002329189 / 2022-10-03
Application Title: Beginners Studio Template.
Title: Beginners Studio Template.
Description: Print material, 4 p.
Series: Aquabeads
Copyright Claimant: EPOCH COMPANY, LTD. Address: 2-2, 2-Chome, Komagata, Taito-ku, Tokyo, 111-8618, Japan.
Date of Creation: 2016
Date of Publication: 2016-12-21
Nation of First Publication: United States
Authorship on Application: EPOCH COMPANY, LTD., employer for hire; Domicile: Japan. Authorship: 2-D artwork.
Copyright Note: Basis for Registration: A Unit of Publication, which extends to only each individual copyrightable work in the UOP. 17 USC 410(a) and 37 CFR 202.3(b)(4)(i)(A).
Names: EPOCH COMPANY, LTD.

1. 拳击反射球 Boxing Reflex Ball

2.1 产品介绍---拳击反射球 Boxing Reflex Ball

拳击反射球 Boxing Reflex Ball 可以提高手眼协调能力, 不仅适合健身爱好者, 老人和小孩都喜欢玩。



图源：亚马逊

2024 年初在亚马逊上销量相当惊人, 虽然留评只有 636 个, 但是月销量高达 7 万+, 排在亚马逊 Sports Reaction Balls 畅销榜榜首。



2.2 拳击反射球侵权排查--知识产权信息

该产品早于 21 年就下证了美国外观专利。专利号：US D914,122 S



US00D914122S

(12) **United States Design Patent** (10) **Patent No.:** **US D914,122 S**
Pan (45) **Date of Patent:** **** Mar. 23, 2021**

(54) **BOXING REFLEX BALL WITH BAND**

A63B 69/20; A63B 69/203; A63B 69/205; A63B 69/24

(71) Applicant: **Haizhou Pan**, Dongguan (CN)

See application file for complete search history.

(72) Inventor: **Haizhou Pan**, Dongguan (CN)

(56) **References Cited**

(**) Term: **15 Years**

U.S. PATENT DOCUMENTS

(21) Appl. No.: **29/737,063**

3,951,414 A * 4/1976 Nunez A63B 69/3608
473/210
4,021,035 A * 5/1977 O'Hara A63B 69/0086
482/88

(22) Filed: **Jun. 5, 2020**

4,121,829 A 10/1978 Petrussek
(Continued)

(30) **Foreign Application Priority Data**

May 29, 2020 (EM) 007975727-0001

FOREIGN PATENT DOCUMENTS

(51) **LOC (13) Cl.** **21-02**

CA 2208050 A1 * 2/1999 A63B 69/26

(52) **U.S. Cl.**

CN 304927803 * 12/2018

USPC **D21/787**; D21/466; D21/719

(Continued)

(58) **Field of Classification Search**

OTHER PUBLICATIONS

USPC D21/309, 466, 662, 698, 780, 719, 787,
D21/789, 791, 798; D3/215, 218, 221,
D3/254, 257, 259, 260, 262, 318, 322,
D3/328, 329, 225, 229; D30/144,
D30/151-154, 160; D2/866, 877, 881,
D2/891, 894, 614, 623, 625, 627, 629,
D2/610, 624, 639; D11/200, 201, 3;
D24/128, 188, 190-192, 127; 473/423,
473/424, 430; 482/88; 2/171, 171.2,
2/171.5, 171.7, 171.8, 209.13, 300,
2/312-321, 917-920, DIG. 11; 224/181,
224/182, 660, 676, 249, 267, 901-901.8;
604/179; 128/876, DIG. 15, DIG. 26;
273/DIG. 17, DIG. 19

Punching Mania Boxing Reflex Ball (Year: 2020).*
(Continued)

Primary Examiner — Catherine A Tuttle

(57)

CLAIM

The ornamental design for a boxing reflex ball with band, as shown and described.

DESCRIPTION

CPC A63B 43/007; A63B 2043/001; A63B 69/0073; A63B 69/0075; A63B 69/0079; A63B 69/0086; A63B 69/26; A63B 69/3688; A63B 2244/102; A63B 67/10;

FIG. 1 is a perspective view of a boxing reflex ball with band showing my new design in a first state;
FIG. 2 is a front elevational view thereof;
FIG. 3 is a rear elevational view thereof;
FIG. 4 is a left side elevational view thereof;
FIG. 5 is a right side elevational view thereof;
FIG. 6 is a top plan view thereof;
FIG. 7 is a bottom plan view thereof; and,
FIG. 8 is a perspective view of the boxing reflex ball with hand in a second state.

The broken lines in the drawings depict portions of the boxing reflex ball and tether that form no part of the claimed design.

1 Claim, 8 Drawing Sheets

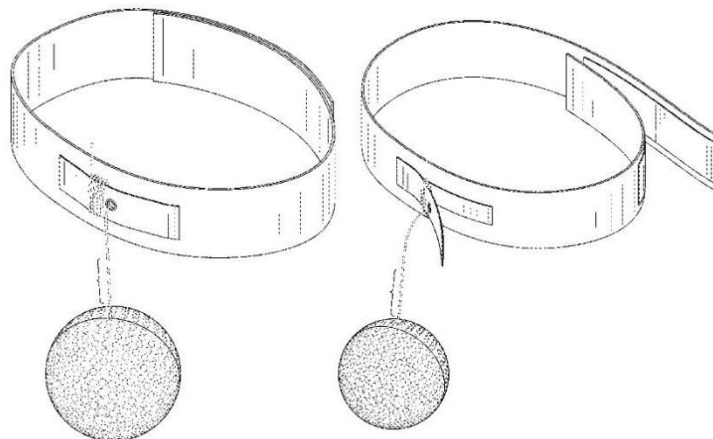

2. 水上充气艇 inflatable object

3.1 产品信息--水上充气艇 inflatable object

原告 Pool Punisher LLC 于 2024 年 1 月发起了水上充气艇 inflatable object 的专利维权。该产品也是亚马逊的热销产品



图源：亚马逊

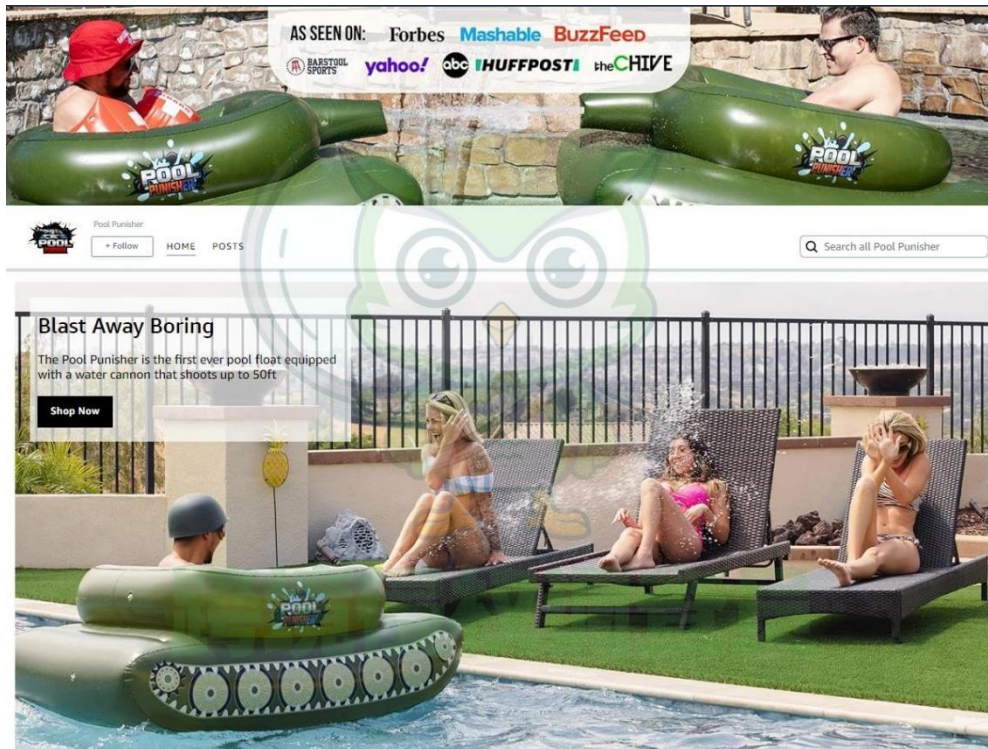

3.2 水上充气艇 inflatable object--知识产权信息

Pool Punisher LLC 旗下已下证了 4 个美国外观专利：US D974,516 S、US D981,519 S、US D1,000,565 S、US D1,003,381 S

US000974516S

(12) **United States Design Patent** (10) **Patent No.:** **US D974,516 S**
(45) **Date of Patent:** ** **Jan. 3, 2023**

(54) **INFLATABLE OBJECT**
(71) Applicant: **POOL PUNISHER LLC**, San Diego, CA (US)
(72) Inventors: **Patrick Wallace Frank**, San Diego, CA (US); **George Alexander Kramb**, San Diego, CA (US)
(73) Assignee: **POOL PUNISHER LLC**, San Diego, CA (US)

(**) Term: **15 Years**
(21) Appl. No.: **29/866,312**
(22) Filed: **Sep. 8, 2022**
(51) **LOC (14) Cl.** **21-04**
(52) **U.S. CL** **D21/835**
(58) **Field of Classification Search**
USPC D21/433, 548, 549, 835, D12/86
CPC B62D 25/00; B62D 25/06; B62D 33/00; B62D 35/00

See application file for complete search history.

References Cited

U.S. PATENT DOCUMENTS

D355,466 S	* 2/1995	Wolfe	
5,512,002 A	* 4/1996	Lieberman	A63H 17/00
D377,814 S	* 2/1997	Lieberman	448/221
D393,682 S	* 4/1998	Peterson	
D413,953 S	* 9/1999	Peterson	
D414,235 S	* 9/1999	Peterson	
D417,481 S	* 12/1999	Schwartz	D12/401
D428,099 S	* 7/2000	Peterson	
D428,099 S	* 7/2000	Peterson	
D435,824 S	* 1/2001	Peterson	
D437,822 S	* 1/2001	Gouchouman	D21/835
D437,379 S	* 2/2001	Peterson	
D437,380 S	* 2/2001	Gouchouman	D21/835

OTHER PUBLICATIONS

Inflatable Floating Bed Float; Inflatable Tank. Jun. 24, 2021. amazon.ca, Nov. 2, 2022. URL: <https://www.amazon.ca/Swimming-Inflatable-Floating-Armored-Vehicld-dp-B097T6XCNN> (Year: 2021)*
(Continued)

DESCRIPTION

FIG. 1 is a top, front, right perspective view of an inflatable object, showing our new design;
FIG. 2 is a top, back, left perspective view thereof;
FIG. 3 is a front elevational view thereof;
FIG. 4 is a back elevational view thereof;
FIG. 5 is a left side elevational view thereof;
FIG. 6 is a right side elevational view thereof;
FIG. 7 is a top plan view thereof; and,
FIG. 8 is a bottom plan view thereof.

The broken line showing of environmental matter is for illustrative purposes only and forms no part of the claimed design.

1 Claim, 8 Drawing Sheets



US000981519S

(12) **United States Design Patent** (10) **Patent No.:** **US D981,519 S**
(45) **Date of Patent:** ** **Mar. 21, 2023**

(54) **INFLATABLE OBJECT**
(71) Applicant: **POOL PUNISHER LLC**, San Diego, CA (US)
(72) Inventors: **George Alexander Kramb**, San Diego, CA (US); **Patrick Wallace Frank**, San Diego, CA (US)
(73) Assignee: **Pool Punisher, LLC**, San Diego, CA (US)

(**) Term: **15 Years**
(21) Appl. No.: **29/783,831**
(22) Filed: **May 14, 2021**
(51) **LOC (14) Cl.** **21-02**
(52) **U.S. CL** **D21/808**
(58) **Field of Classification Search**
USPC D21/770, 803, 809, 835, 836; 114/54, 114/123, 267, 345, 472/129, 446/220
CPC A63B 69/187; A63B 2225/605; A63B 2225/62; A63B 2225/609; B63B 34/52; B63B 34/54; B63B 34/63; B63B 35/58; B63B 7/08; B63B 34/00

See application file for complete search history.

References Cited

U.S. PATENT DOCUMENTS

D912,759 S	* 3/2021	Lei	D21/803
D954,887 S	* 6/2022	Zhou	D21/808
D957,563 S	* 7/2022	Zhang	D21/808
D968,549 S	* 11/2022	Zhou	D21/808

FOREIGN PATENT DOCUMENTS

GB 6215457 * 6/2022
* cited by examiner

CLAIM

(57) **CLAIM**
The ornamental design for an inflatable object, as shown and described.

DESCRIPTION

FIG. 1 is a perspective view of an inflated inflatable object showing our new design;
FIG. 2 is a front view of the inflated inflatable object;
FIG. 3 is a rear view of the inflated inflatable object;
FIG. 4 is a side view of the inflated inflatable object;
FIG. 5 is a side view of the inflated inflatable object;
FIG. 6 is a top view of the inflated inflatable object; and,
FIG. 7 is a bottom view of the inflated inflatable object.

The broken lines in the drawings showing elements of the inflated inflatable object represent unclaimed portions of the inflatable object and form no part of the claimed design.

1 Claim, 4 Drawing Sheets





(12) **United States Design Patent** (10) Patent No.: **US D1,000,565 S**
 Kramb et al. (45) Date of Patent: ** Oct. 3, 2023

(54) **INFLATABLE OBJECT** D872,195 S 1/2020 Jia
 D904,539 S 12/2020 Barrett
 D908,831 S 1/2021 May
 D912,759 S 3/2021 Lai
 D914,126 S 3/2021 May
 D925,684 S 7/2021 Huang
 D930,102 S 9/2021 Huang
 D930,778 S 9/2021 Hsu (Continued)

(71) Applicant: **POOL PUNISHER LLC**, San Diego, CA (US)

(72) Inventors: **George Alexander Kramb**, San Diego, CA (US); **Patrick Wallace Frank**, San Diego, CA (US)

(73) Assignee: **POOL PUNISHER LLC**, San Diego, CA (US)

(**) Term: **15 Years**

(21) Appl. No.: **29/871,237**

(22) Filed: **Feb. 15, 2023**

Related U.S. Application Data
 (63) Continuation of application No. 29/783,831, filed on May 14, 2021, now Pat. No. Des. 981,519.

(51) **LOC (14) CL** **21-02**

(52) **U.S. CL** **D21/808; D21/803**

(58) **Field of Classification Search**
 USPC D21/801, 803, 808, 809, 835, 441/66, 441/129, 130
 CPC A63H 23/10; A63H 23/16; B63B 34/52; B63B 34/50

See application file for complete search history.

(56) **References Cited**
 U.S. PATENT DOCUMENTS
 D169,229 S 3/1953 Toben
 D435,882 S 1/2001 Pedersen
 D437,022 S 1/2001 Gounibounian
 D616,055 S 5/2010 Zamperla
 D665,865 S 8/2012 Goode
 D825,683 S 8/2018 Liu
 D868,188 S 11/2019 Barrett
 D870,834 S 12/2019 Hsu

1 Claim, 4 Drawing Sheets



OTHER PUBLICATIONS
 The Original Pool Punisher Inflatable Pool Float—Inflatable Tank Floats w/ Functional Pump-Action Water Cannon—Heat Water up to 50°!—Durable Inflatable Pool Floats for Adults & Kids Ages 5+, as shown in www.amazon.com, Mar. 31, 2021, ASIN B08F3VY9R3. (Year: 2021)*

Primary Examiner—Gino Colan
Assistant Examiner—Gregory G McLemore
 (74) **Attorney, Agent, or Firm**—NorthStar Law Group (57)

CLAIM
 The ornamental design for an inflatable object, as shown and described.

DESCRIPTION
 FIG. 1 is a perspective view of an inflated inflatable object showing our new design;
 FIG. 2 is a front view of the inflated inflatable object;
 FIG. 3 is a rear view of the inflated inflatable object;
 FIG. 4 is a side view of the inflated inflatable object;
 FIG. 5 is a side view of the inflated inflatable object;
 FIG. 6 is a top view of the inflated inflatable object; and
 FIG. 7 is a bottom view of the inflated inflatable object.
 The broken lines in the drawings showing elements of the inflated inflatable object represent unclaimed portions of the inflatable object and form no part of the claimed design.



(12) **United States Design Patent** (10) Patent No.: **US D1,003,381 S**
 Frank et al. (45) Date of Patent: ** Oct. 31, 2023

(54) **POOL FLOAT FEATURING A HUMAN FIGURE PROJECTING FROM A TUBE** D445,285 S * 7/2001 Kwapis D21/808
 D443,150 S 12/2001 Chan
 D457,216 S 5/2002 Fraz (Continued)

(71) Applicant: **POOL PUNISHER LLC**, San Diego, CA (US)

(72) Inventors: **Patrick Wallace Frank**, San Diego, CA (US); **George Alexander Kramb**, San Diego, CA (US)

(73) Assignee: **POOL PUNISHER LLC**, San Diego, CA (US)

(**) Term: **15 Years**

(21) Appl. No.: **29/869,673**

(22) Filed: **Jan. 6, 2023**

(51) **LOC (14) CL** **21-02**

(52) **U.S. CL** **D21/808; D21/803**

(58) **Field of Classification Search**
 USPC D21/803, 804, 808, 473; D12/316; D7/400, 619/2; D6/508, 333, 472/129
 CPC A63H 23/10; A63H 3/06; A63H 3/005; A63H 15/006; A63H 22/505; A63H 67/007; A63H 22/0803; A63H 22/25/62; A63H 31/00; B63B 34/52; B63B 34/50; B63B 34/54; B63B 7/002; B63B 35/58; B63B 7/008; B63B 34/000

See application file for complete search history.

(56) **References Cited**
 U.S. PATENT DOCUMENTS
 1,566,858 A * 12/1925 Guindburg B63C 9/08
 433
 D287,870 S 1/1987 Wolfe
 D291,888 S * 9/1987 Wolfe D12/316
 D301,010 S * 6/1989 Wolfe D21/808
 D347,329 S * 5/1994 Wilkins D6/333

OTHER PUBLICATIONS
 "Pool Float Donald Trump 2024 Inflatable Raft Pool Ring XL", Amazon.com, accessed on Jan. 5, 2023, 1) https://www.amazon.com/NinoStar-USA-Float-tp/B0719GVFSP/ (Continued)

Primary Examiner—Ryan Harvey
 (74) **Attorney, Agent, or Firm**—NorthStar Law Group (57)

CLAIM
 The ornamental design for a pool float featuring a human figure projecting from a tube, as shown and described.

DESCRIPTION
 FIG. 1 is a top, front perspective view of a design for a pool float featuring a human figure projecting from a tube;
 FIG. 2 is a front view thereof;
 FIG. 3 is a rear view thereof;
 FIG. 4 is a left side view thereof;
 FIG. 5 is a right side view thereof;
 FIG. 6 is a top view thereof;
 FIG. 7 is a bottom view thereof;
 FIG. 8 is a top, rear perspective view thereof;
 FIG. 9 is a bottom, rear perspective view thereof;
 FIG. 10 is a top, front perspective view thereof with unclaimed artwork thereon approximating a political figure and political design;
 FIG. 11 is a top, front perspective view thereof with unclaimed artwork thereon approximating a political figure and political design; and
 FIG. 12 is a bottom, rear perspective view thereof with unclaimed artwork thereon approximating a political figure and political design.
 The broken lines showing of portions of the design depicts environment and forms no part of the claim.

1 Claim, 12 Drawing Sheets



该公司还登记了多个美国版权，并于 2022 年发起过版权维权（22-cv-5947），

#	Name (NALL) <	Full Title	Copyright Number	Date
[1]	Pool Punisher LLC	PLP-Video-1 and 2 Other Unpublished Works.	PAu004144554	2022
[2]	Pool Punisher LLC	Pool Punisher Product Pictures 2021. [Group registration of published photographs. 19 photographs. 2021-02-01 to 2021-08-01]	VA0002310038	2021
[3]	Pool Punisher LLC	Pool Punisher Product Pictures 2022. [Group registration of published photographs. 4 photographs. 2022-05-01 to 2022-05-01]	VA0002316351	2022
[4]	Pool Punisher LLC DBA Float Factory	Float Factory 2023. [Group registration of published photographs. 76 photographs. 2023-01-15 to 2023-04-04]	VA0002360902	2023

另外该公司旗下还注册了 4 个商标，注册在 28 类户处于玩具大类，

POOL PUNISHER	PUNISH PUMPER
Wordmark POOL PUNISHER	Wordmark PUNISH PUMPER
Status LIVE REGISTERED	Status LIVE REGISTERED
Goods & services IC 028: Inflatable pool toys; Swimming pool air floats.	Goods & services IC 028: Toy water guns; Water squirting toys.
Class 028	Class 028
Serial 97283521	Serial 97541075
Owners Pool Punisher LLC (LIMITED LIABILITY COMPANY; CALIFORNIA, USA)	Owners Pool Punisher LLC (LIMITED LIABILITY COMPANY; CALIFORNIA, USA)

FLOAT FACTORY	FORMULA FLOAT
Wordmark FLOAT FACTORY	Wordmark FORMULA FLOAT
Status LIVE REGISTERED	Status LIVE REGISTERED
Goods & services IC 028: Inflatable pool toys; Swimming pool air floats.	Goods & services IC 028: Inflatable pool toys; Swimming pool air floats.
Class 028	Class 028
Serial 97615632	Serial 97550547
Owners Pool Punisher LLC (LIMITED LIABILITY COMPANY; CALIFORNIA, USA)	Owners Pool Punisher LLC (LIMITED LIABILITY COMPANY; CALIFORNIA, USA)

4、Fin Fun 美人鱼尾巴

4.1.产品介绍---Fin Fun 美人鱼尾巴

Fin Fun 是一个游泳用品的品牌，主要销售美人鱼尾巴、单蹼、泳衣及游泳配件等商品。本案维权内容广泛，涉及商标 专利和版权。



图源：官网

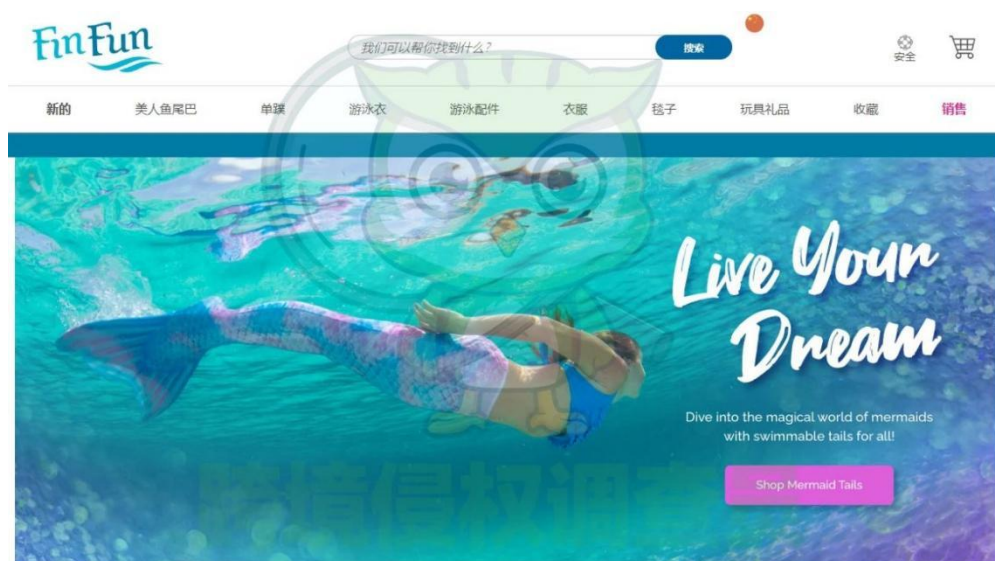

4.2 Fin Fun 美人鱼尾巴-----知识产权信息

本案涉及商标是 FIN FUN，注册在 25 类服装鞋帽和 28 类户外与玩具大类。



维权专利有两个，一个是美国发明专利，于 2015 年 10 月下证，专利号：US 9,162,110 B1；另一个是美国外观专利，于 2023 年 2 月下证，专利号：US D979,694 S。



US009162110B1

(12) **United States Patent**
Browning et al.

(10) **Patent No.:** **US 9,162,110 B1**
(45) **Date of Patent:** **Oct. 20, 2015**

(54) **MONOFIN, TAIL AND METHOD**

2011/0217890 A1 9/2011 Fleck
2011/0250818 A1 10/2011 Geurts
2012/0252289 A1 10/2012 Johnson

(71) Applicant: **BLUE SPRING PARTNERS, LLC,**
Rigby, ID (US)

FOREIGN PATENT DOCUMENTS

(72) Inventors: **Eric Browning,** Shelley, ID (US);
Steven Browning, Rigby, ID (US);
Brent Houghton, Shelley, ID (US); **Kyle**
Kinghorn, Rexburg, ID (US)

WO 9211176 A1 7/1992

OTHER PUBLICATIONS

(*) Notice: Subject to any disclaimer, the term of this patent is extended or adjusted under 35 U.S.C. 154(b) by 0 days.

Mermaid Tails website: www.mermaidtails.net.
Aqua Tails website: www.aquatails.com.
Mermagic website: www.mermagic.com.
Mermaid Fin website: www.mermaidfin.com.
Monofin website: www.monofin.org/monofin-beginner.htm.
Metro Swim Shop website: www.metroswimshop.com/product/Finis%20Wave.htm#.U0cNqtJOWcw.
Lumugdano, Abigail T., "Explore the mythical world of fitness through mermaid swimming," Health & Fitness, Apr. 13, 2014, www.businessmirror.com.
Miami Beach Mermaids website: <http://www.miamibeachmermaids.com/#/mermaid-store/c1sn6>.
The Mertailor website: <https://themertailor.com/monofin-flipper>.
Fin Fun Mermaid. How to us a Fin Fun Monofin. YouTube. Feb. 15, 2014. [retrieved on Apr. 14, 2015]. Retrieved from Internet: <URL:<https://www.youtube.com/watch?v=TnJO7ch37js>>, entire video.

(21) Appl. No.: **14/286,735**

(22) Filed: **May 23, 2014**

(51) **Int. Cl.**
A63B 31/11 (2006.01)

(52) **U.S. Cl.**
CPC **A63B 31/11** (2013.01)

(58) **Field of Classification Search**
CPC A63B 31/00; A63B 31/08; A63B 31/11;
A63B 31/12
USPC 441/60, 61, 64
See application file for complete search history.

Primary Examiner — Lars A Olson

(74) *Attorney, Agent, or Firm* — Robert L. Shaver; Shaver & Swanson, LLP

(56) **References Cited**

U.S. PATENT DOCUMENTS

3,344,449 A 10/1967 Grilli
3,934,290 A 1/1976 Le Vasseur
4,541,810 A 9/1985 Wenzel
4,781,637 A 11/1988 Cairns
5,429,536 A 7/1995 Evans
6,086,440 A 7/2000 Fechtner
6,375,530 B1 4/2002 Earl
6,764,362 B1 7/2004 Wenzel
8,382,542 B2 2/2013 Pakhomov
8,632,372 B2 1/2014 Fleck

(57) **ABSTRACT**

A monofin, mermaid tail, and method of applying the tail and monofin. The fin utilizes a core made of flexible, yet resilient material such as plastic and a cover that is elastic, such as neoprene. The user's feet are connected to the fin by releasable connections. The mermaid tail and monofin connects both of a user's feet and legs in order to facilitate swimming in a mermaid-like motion while giving the user the appearance of a mermaid.

15 Claims, 5 Drawing Sheets

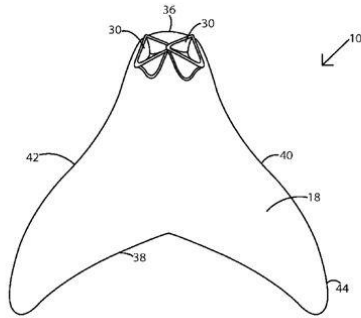



US00D979694S

(12) **United States Design Patent** (10) **Patent No.:** **US D979,694 S**
Browning et al. (45) **Date of Patent:** **** Feb. 28, 2023**

(54) **MONOFIN SWIMMING DEVICE** D658,736 S * 5/2012 Melius D21/806
D789,474 S * 6/2017 Abruzzini D21/806
(71) Applicant: **Blue Springs Partners, LLC**, Idaho D865,099 S * 10/2019 Xu D21/806
Falls, ID (US) D877,271 S * 3/2020 Hu D21/806
D895,755 S * 9/2020 Browning D21/806

(72) Inventors: **Steven Browning**, Rigby, ID (US); * cited by examiner
Peter Solomon, Fort Lauderdale, FL (US) *Primary Examiner* — Zenia I Bennett
(73) Assignee: **Blue Springs Partners, LLC**, Idaho (74) *Attorney, Agent, or Firm* — Park, Vaughan, Fleming & Dowler LLP
Falls, ID (US)

(**) Term: **15 Years**

(57) **CLAIM**

(21) Appl. No.: **29/747,611**

The ornamental designs for a monofin swimming device, as shown and described.

(22) Filed: **Aug. 24, 2020**

(51) **LOC (14) Cl.** **21-01**

(52) **U.S. Cl.** **D21/806**
USPC

DESCRIPTION

(58) **Field of Classification Search**
USPC D21/801, 803, 804, 806, 807
CPC A63B 31/00; A63B 31/02; A63B 31/08;
A63B 31/10; A63B 31/11
See application file for complete search history.

FIG. 1 is a top perspective view of a monofin swimming device showing our new design.
FIG. 2 is a top perspective view thereof.
FIG. 3 is a top view thereof.
FIG. 4 is a bottom view thereof.
FIG. 5 is a side view thereof.
FIG. 6 is a front view thereof; and,
FIG. 7 is a back view thereof.

(56) **References Cited**

U.S. PATENT DOCUMENTS

D328,118 S * 7/1992 Evans D21/806
D415,544 S * 10/1999 Applegate D21/806

1 Claim, 6 Drawing Sheets

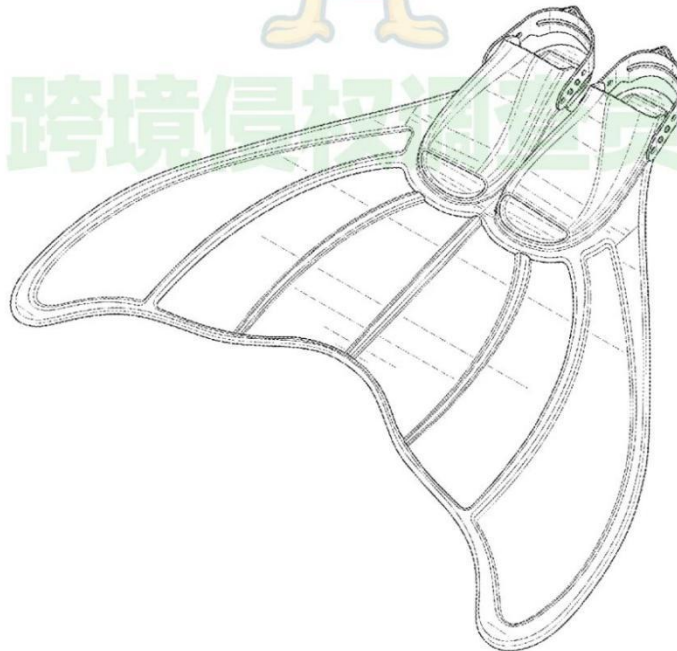

本案还涉及 77 张美人鱼尾巴和鱼鳞的版权图，



5、Building block toy 积木类拼装玩具

5.1 产品介绍---积木类拼装玩具

积木 Building block toy 可以提高孩子的思考能力和动手能力，因此深受家长青睐。在亚马逊上搜索关键词“Building block toy”，映入眼帘的除了五

颜六色的产品之外, 还有数额巨大的销量, 许多产品近一个月的销量高达 10K+, 有的链接留评累计高达 8 万+。

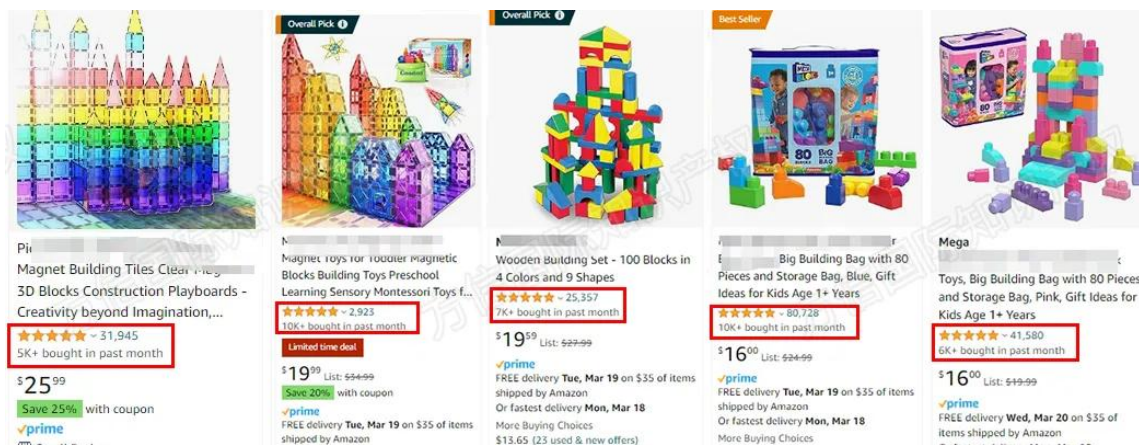

5.2 积木类拼装玩具----知识产权信息

积木 Building block toy 形状各式各样, 因此侵权风险非常高。以下是检索到的部分美国外观专利: US D1,001,201 S、US D1,004,007 SUS D1,010,019 S、US D888,163 SUS D928,239 S、US D959,563 SUS D975,199 S、US D979,662 S、US D981,496 S



(12) **United States Design Patent** (10) **Patent No.:** **US D1,010,019 S**
Mou (45) **Date of Patent:** **** Jan. 2, 2024**

(54) **BUILDING BLOCK TOY**

(71) Applicant: **Fangdong Mou, Yiwu (CN)**

(72) Inventor: **Fangdong Mou, Yiwu (CN)**

(**) Term: **15 Years**

(21) Appl. No.: **29/800,141**

(22) Filed: **Jul. 19, 2021**

(51) **LOC (14) Cl.** **21-01**

(52) **U.S. Cl.**
 USPC **D21/491**

(58) **Field of Classification Search**

USPC D21/468, 478, 479, 484-505
 CPC A63H 33/00; A63H 33/04; A63H 33/044;
 A63H 33/06; A63H 33/062; A63H
 33/086; A63H 33/088; A63H 33/10;
 A63H 33/101; A63H 33/108; A63H 33/12
 See application file for complete search history.

(56) **References Cited**

U.S. PATENT DOCUMENTS

7,648,407 B1 * 1/2010 Sorensen A63H 33/084
 446/124
 8,187,050 B1 * 5/2012 Sorensen A63H 33/084
 446/124
 D723,630 S * 3/2015 Kanbar D21/485
 D802,058 S * 11/2017 Ishaque D21/501
 D828,458 S * 9/2018 Dumphy D21/500

D843,493 S * 3/2019 Dumphy D21/499
 D864,307 S * 10/2019 Farsad D21/491
 D960,253 S * 8/2022 Zeng A63H 33/084
 D21/493
 D969,232 S * 11/2022 Park A63H 33/084
 D21/491

* cited by examiner

Primary Examiner — Cynthia M. Chin
 (74) *Attorney, Agent, or Firm* — Che-Yang Chen; Law
 Office of Michael Chen

(57) **CLAIM**

The ornamental design for a building block toy, as shown and described.

DESCRIPTION

FIG. 1 is a perspective view of the building block toy showing my new design;
 FIG. 2 is a front elevational view thereof;
 FIG. 3 is a rear elevational view thereof;
 FIG. 4 is a left side elevational view thereof;
 FIG. 5 is a right side elevational view thereof;
 FIG. 6 is a top plan view of thereof;
 FIG. 7 is a bottom plan view of thereof; and,
 FIG. 8 is a perspective view thereof when more than one building block toy is connected.

The broken lines in FIG. 3 are for the purpose of illustrating portions of the article that form no part of the claimed design. The broken lines in FIG. 8 represent the environment in which the article resides and form no part of the claimed design.

1 Claim, 8 Drawing Sheets

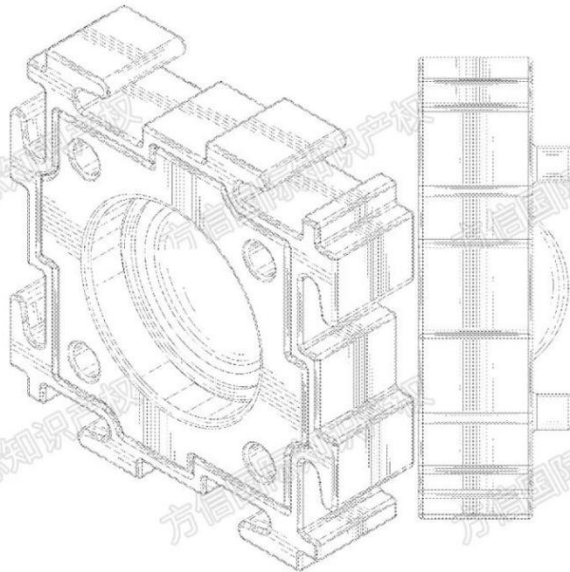



US0D1004007S

(12) **United States Design Patent** (10) **Patent No.:** **US D1,004,007 S**
Kiribuchi (45) **Date of Patent:** **** Nov. 7, 2023**

(54) **ASSEMBLING TOY**

(71) Applicant: **People Co., Ltd.**, Tokyo (JP)

(72) Inventor: **Masato Kiribuchi**, Tokyo (JP)

(73) Assignee: **PEOPLE CO., LTD.**, Tokyo (JP)

(**) Term: **15 Years**

(21) Appl. No.: **29/841,367**

(22) Filed: **Jun. 6, 2022**

(30) **Foreign Application Priority Data**

Dec. 10, 2021 (JP) 2021-027210 D

(51) **LOC (14) Cl.** **21-01**

(52) **U.S. Cl.** **D21/505; D21/404**

(58) **Field of Classification Search**

USPC D21/404, 483, 484, 489, 490, 493, 494,
D21/504, 505

CPC A63H 33/046; A63H 33/26

See application file for complete search history.

(56) **References Cited**

U.S. PATENT DOCUMENTS

D729,116 S *	5/2015	Riccobono	D11/165
D813,955 S *	3/2018	Henkin	D21/489
D823,946 S *	7/2018	Henkin	D21/404
D827,721 S *	9/2018	Wang	D21/404
D829,825 S *	10/2018	Henkin	D21/404
D867,263 S *	11/2019	Ornstein	D21/505
D893,635 S *	8/2020	Henkin	D21/404
D894,284 S *	8/2020	Kogure	D21/364
D894,289 S *	8/2020	Henkin	D21/404
D922,495 S *	6/2021	Lv	D21/404
D928,239 S *	8/2021	Wang	D21/489
D929,505 S *	8/2021	Wang	D21/490
D959,563 S *	8/2022	Lyu	D21/404

D981,496 S *	3/2023	Zhu	D21/404
2014/0302741 A1 *	10/2014	Whittaker	A63H 33/046 446/92
2016/0184727 A1 *	6/2016	Ornstein	A63H 33/046 446/92

OTHER PUBLICATIONS

MVW Holdings, "Magna-Tiles Clear Colors 32-Piece Set", URL: <https://www.magnatiles.com/product/magna-tiles-clear-colors-32-piece-set/#top>, retrieved on Aug. 12, 2022.

* cited by examiner

Primary Examiner — Cynthia M. Chin

(74) *Attorney, Agent, or Firm* — Leydig, Voit & Mayer, Ltd.

(57) **CLAIM**

The ornamental design for an assembling toy, as shown and described.

DESCRIPTION

FIG. 1 is a front view of an assembling toy of the present invention.

FIG. 2 is a rear view thereof.

FIG. 3 is a top plan view thereof.

FIG. 4 is a bottom plan view thereof.

FIG. 5 is a right side view thereof.

FIG. 6 is a left side view thereof.

FIG. 7 is a perspective view thereof.

FIG. 8 is a sectional view thereof taken along section line 8-8 of FIG. 1.

FIG. 9 is a sectional view thereof taken along section line 9-9 of FIG. 1; and,

FIG. 10 is a sectional view thereof taken in the direction of section line 10-10 of FIG. 5.

1 Claim, 10 Drawing Sheets

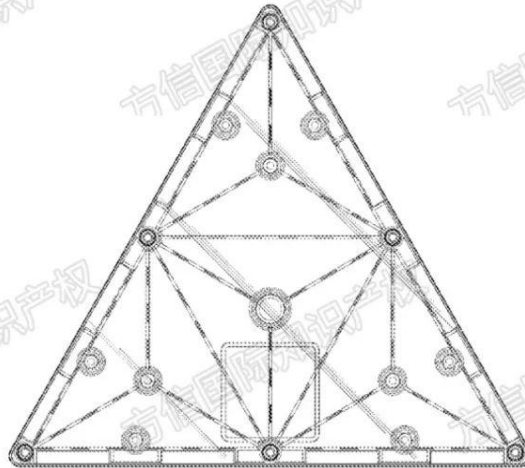



US00D981496S

(12) **United States Design Patent** (10) **Patent No.:** **US D981,496 S**
Zhu (45) **Date of Patent:** **** Mar. 21, 2023**

(54) **MAGNETIC TILES SET**
(71) Applicant: **Wuyi Lizewei Industry and Trade Co., Ltd., Jinhua (CN)**
(72) Inventor: **Cong Zhu, Yongkang (CN)**
(**) Term: **15 Years**
(21) Appl. No.: **29/846,680**
(22) Filed: **Jul. 19, 2022**
(51) **LOC (14) Cl.** **21-01**
(52) **U.S. Cl.** **D21/404**
(58) **Field of Classification Search**
USPC **D21/404, 484, 489, 490, 491, 494, 500, D21/501, 504, 505, 385, 386; D6/303, D6/312, 314; D13/183; D25/103, 104, D25/106, 109, 110, 111**
CPC **A63F 9/34; A63F 2003/00391; A63F 2009/1033; A63F 2009/1212; A63H 33/044; A63H 33/046; A63H 33/26; A63H 33/10; A63H 33/06; A63H 33/12; A63H 33/04; G09B 1/38**
See application file for complete search history.

D784,938 S * 4/2017 Wang D21/491
D789,312 S * 6/2017 Wang D21/491
D799,604 S 10/2017 Wang
D813,955 S 3/2018 Henkin
D823,946 S 7/2018 Henkin
D827,720 S * 9/2018 Whang D21/404
D827,721 S 9/2018 Whang
D829,825 S 10/2018 Henkin
D830,475 S * 10/2018 Wang D21/491
D831,129 S * 10/2018 Wang D21/491
D849,850 S * 5/2019 Holowka D21/484
D867,263 S * 11/2019 Ornstein D21/505
D893,635 S * 8/2020 Henkin
D894,284 S * 8/2020 Kogure D21/364
D894,289 S 8/2020 Henkin
D922,495 S 6/2021 Lv
D922,501 S 6/2021 Lv
D928,239 S * 8/2021 Wang D21/489
D929,505 S * 8/2021 Wang D21/490
D959,563 S * 8/2022 Lyu D21/404
2002/0119725 A1* 8/2002 Pupulin A63H 33/04
446/85
2016/0184727 A1* 6/2016 Ornstein A63H 33/046
446/92
2017/0182429 A1* 6/2017 Choi A63H 33/046
2020/0246715 A1* 8/2020 Bensussan A63H 33/10
2021/0291069 A1* 9/2021 Zhou A63H 33/26

OTHER PUBLICATIONS

Desire Deluxe Magnetic Building Blocks Tiles STEM Toy Set 57PC. Date First Available: Feb. 28, 2018. Retrieved from internet: <<https://www.amazon.co.uk/Desire-Deluxe-Magnetic-Blocks-Building/dp/B07MGYKZ36?th=1>> [site visited Oct. 17, 2022] (Year: 2018).
Magnetic Tiles 102PCS Building Blocks for Kids. Date First Available: Jan. 9, 2021. Retrieved from internet: <<https://www.amazon.co.uk/Compatible-Magnetic-Building-Montessori-Activities/dp/B087FBDL6P/>> [site visited Oct. 17, 2022] (Year: 2021).
MegagonTiles 110PCS Premium Magnetic Tiles. Date First Available: Aug. 5, 2021. Retrieved from internet: <<https://www.amazon.com.au/dp/B08XZMST3F/>> [site visited Apr. 20, 2022] (Year: 2021).
Steam Studio 110pcs Premium Magnetic Tiles. Date First Available: Jun. 16, 2021. Retrieved from internet: <<https://www.amazon.com.au/dp/B091BY74M8/>> [site visited Apr. 20, 2022] (Year: 2021).*

* cited by examiner

Primary Examiner — Katherine Glennon
Assistant Examiner — Yuan Yuan

(56) **References Cited**
U.S. PATENT DOCUMENTS
3,998,004 A * 12/1976 Ehrlich A63H 33/046
446/92
D270,921 S * 10/1983 Morgan D21/364
5,183,430 A * 2/1993 Swann A63H 33/04
446/104
D344,188 S * 2/1994 Dominguez D6/303
D375,007 S * 10/1996 Erickson D6/407
5,620,325 A * 4/1997 Glick G09B 19/0023
446/85
D422,035 S * 3/2000 Cyrus D21/501
D423,794 S * 5/2000 Brownfield D6/300
D632,346 S * 2/2011 Hardstaff D21/501
D713,891 S * 9/2014 Schwartz D21/342
D771,752 S 11/2016 Henkin
D773,562 S * 12/2016 Kiribuchi D21/489
D773,564 S * 12/2016 Kiribuchi D21/489

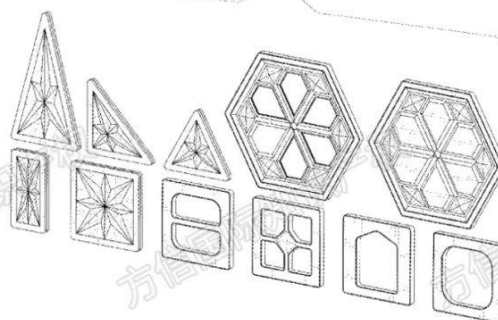



US00D979662S

(12) **United States Design Patent** (10) **Patent No.:** **US D979,662 S**
Chen (45) **Date of Patent:** **** Feb. 28, 2023**

(54) **CONSTRUCTION TOY**

(71) Applicant: **Yingfan Chen, Guangzhou (CN)**

(72) Inventor: **Yingfan Chen, Guangzhou (CN)**

(**) Term: **15 Years**

(21) Appl. No.: **29/769,817**

(22) Filed: **Feb. 8, 2021**

(51) **LOC (14) Cl.** **21-01**

(52) **U.S. Cl.**
USPC **D21/500**

(58) **Field of Classification Search**
USPC D21/484-505
CPC A63H 33/04; A63H 33/06; A63H 33/062;
A63H 33/08; A63H 33/082; A63H
33/084; A63H 33/086; A63H 33/088
See application file for complete search history.

(56) **References Cited**

U.S. PATENT DOCUMENTS

D435,609 S *	12/2000	Sorensen	D21/900
6,447,360 B1 *	9/2002	Sorensen	A63H 33/062
				446,124
D465,246 S *	11/2002	Sorensen	D21/499
D470,196 S *	2/2003	Sorensen	D21/499
D545,920 S *	7/2007	Sorensen	D21/484
D545,921 S *	7/2007	Sorensen	D21/484
D546,901 S *	7/2007	Sorensen	D21/484
D621,883 S *	8/2010	Jou	D21/814
D699,792 S *	2/2014	Hwang	D21/499

D802,058 S *	11/2017	Ishaque	D21/501
D828,458 S *	9/2018	Dumphy	D21/500
D832,937 S *	11/2018	Dumphy	D21/500
D843,493 S *	3/2019	Dumphy	D21/499
D859,539 S *	9/2019	Dumphy	D21/500
10,456,702 B2 *	10/2019	Dumphy	A63H 33/08

* cited by examiner

Primary Examiner — Cynthia M. Chin

(74) Attorney, Agent, or Firm — Kintner IP, LLC; Mary Frances Ludwig

(57) **CLAIM**

The ornamental design for a construction toy, as shown and described.

DESCRIPTION

FIG. 1 is a front left perspective view of the construction toy, illustrating the front, left and bottom sides thereof; FIG. 2 is rear perspective view illustrating the rear, left and top sides thereof; FIG. 3 is a front elevation view thereof; FIG. 4 is a rear elevation view thereof; FIG. 5 is a left plan view thereof; FIG. 6 is a right plan view thereof; FIG. 7 is a top plan view thereof; FIG. 8 is a bottom plan view; and, FIG. 9 is a sectional view taken in the direction of line 9-9 in FIG. 3.

1 Claim, 9 Drawing Sheets

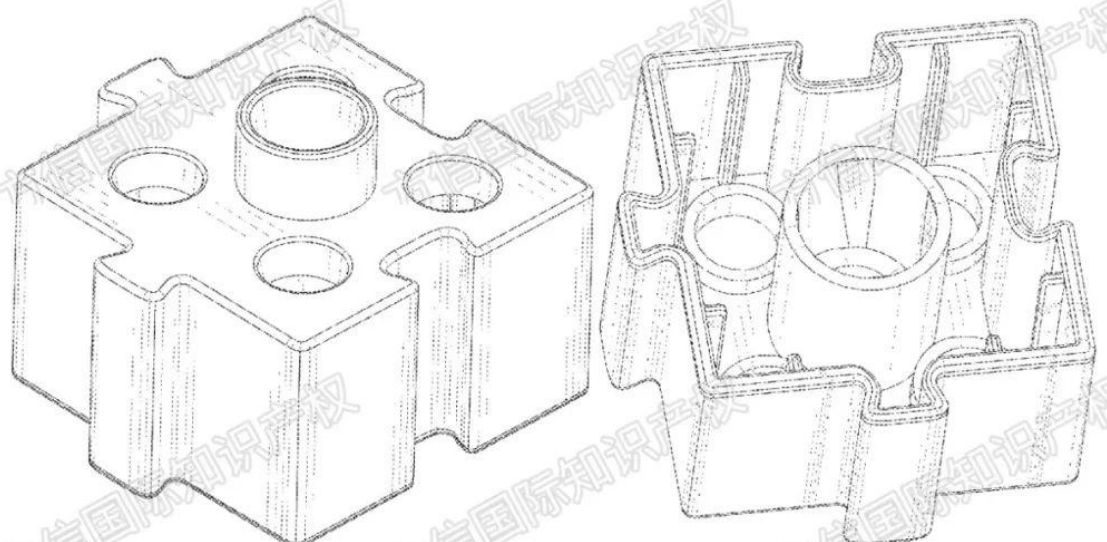



US00D928239S

(12) **United States Design Patent** (10) **Patent No.:** **US D928,239 S**
Wang (45) **Date of Patent:** **** Aug. 17, 2021**

(54) **TOY BRICK SET**

DESCRIPTION

(71) Applicant: **Laltitude LLC**, Hacienda Heights, CA (US)
(72) Inventor: **Howard Wang**, Hacienda Heights, CA (US)
(**) Term: **15 Years**
(21) Appl. No.: **29/767,933**
(22) Filed: **Jan. 26, 2021**
(51) **LOC (13) CL.** **21-01**
(52) **U.S. Cl.**
USPC **D21/489**
(58) **Field of Classification Search**
USPC D21/404, 484, 485, 489, 490, 491, 493, D21/494, 495, 500, 501, 503, 504, 505
(Continued)

(56) **References Cited**

U.S. PATENT DOCUMENTS

5,021,021 A * 6/1991 Ballard A63H 33/046 335/285
D600,291 S 9/2009 Christensen
(Continued)

OTHER PUBLICATIONS

Desire Deluxe Magnetic Tiles Blocks Building Set for Kids on Amazon.com, Reviewed and available online as early as Mar. 23, 2019 [online], [site visited Mar. 25, 2021]. Available from Internet: <URL:https://www.amazon.com/Desire-Deluxe-Magnetic-Blocks-Building/dp/B07MGYKZ36/> (Year: 2019).
(Continued)

Primary Examiner — Cynthia M. Chin
(74) *Attorney, Agent, or Firm* — Clement Cheng

(57) **CLAIM**

The ornamental design for a toy brick set, as shown and described.

FIG. 1 is a perspective front view of a small triangle toy piece.
FIG. 2 is a perspective back view of a small triangle toy piece.
FIG. 3 is a front view of a small triangle toy piece.
FIG. 4 is a left side view of a small triangle toy piece.
FIG. 5 is a right side view of a small triangle toy piece.
FIG. 6 is a top view of a small triangle toy piece.
FIG. 7 is a bottom view of a small triangle toy piece.
FIG. 8 is a back view of a small triangle toy piece.
FIG. 9 is a front view showing optional internal configuration in a dotted line view of a small triangle toy piece.
FIG. 10 is a perspective front view of a straight triangle toy piece.
FIG. 11 is a front view of a straight triangle toy piece.
FIG. 12 is a left side view of a straight triangle toy piece.
FIG. 13 is a right side view of a straight triangle toy piece.
FIG. 14 is a top view of a straight triangle toy piece.
FIG. 15 is a bottom view of a straight triangle toy piece.
FIG. 16 is a back view of a straight triangle toy piece.
FIG. 17 is a perspective front view of a tall triangle toy piece.
FIG. 18 is a perspective back view of a tall triangle toy piece.
FIG. 19 is a front view of a tall triangle toy piece.
FIG. 20 is a left side view of a tall triangle toy piece.
FIG. 21 is a right side view of a tall triangle toy piece.
FIG. 22 is a top view of a tall triangle toy piece.
FIG. 23 is a bottom view of a tall triangle toy piece.
FIG. 24 is a back view of a tall triangle toy piece.
FIG. 25 is a perspective front view of a small square toy piece.
FIG. 26 is a perspective back view of a small square toy piece.
FIG. 27 is a front view of a small square toy piece.
FIG. 28 is a left side view of a small square toy piece.
FIG. 29 is a right side view of a small square toy piece.
FIG. 30 is a top view of a small square toy piece.
FIG. 31 is a bottom view of a small square toy piece.
FIG. 32 is a back view of a small square toy piece.
FIG. 33 is a perspective front view of a half square toy piece.
FIG. 34 is a perspective back view of a half square toy piece.
(Continued)

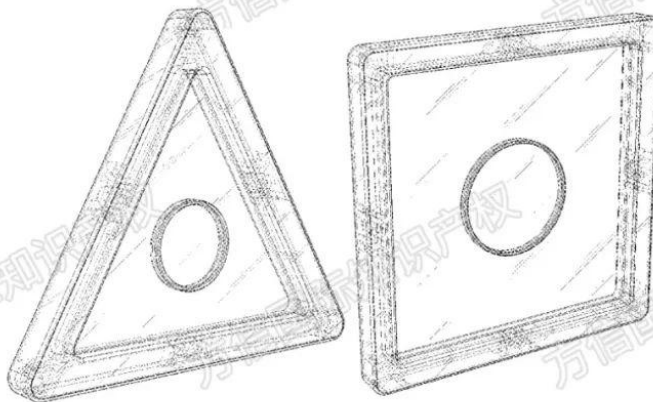

除了以上列出的专利，还要注意商标和版权侵权风险。MAGNA-TILES 积木玩具于 2023 年 6 月 13 号发起过商标维权，维权商标为“MAGNA-TILES”，案件号：23-cv-3720。MATCH MADNESS 积木玩具于 2022 年 5 月 16 号发起过商标维权，维权商标为“MATCH MADNESS”，案件号：22-cv-2552。

6、吸盘旋转玩具 Suction Cup Spinner Toys

6.1 产品介绍---Suction Cup Spinner Toys

亚马逊上这款吸盘旋转玩具 Suction Cup Spinner Toys 非常火爆，在众多类目销量排行榜中排列第一，大部分月销量都有好几千，有的高达 10000+，基本售价都在 9.99 美元。

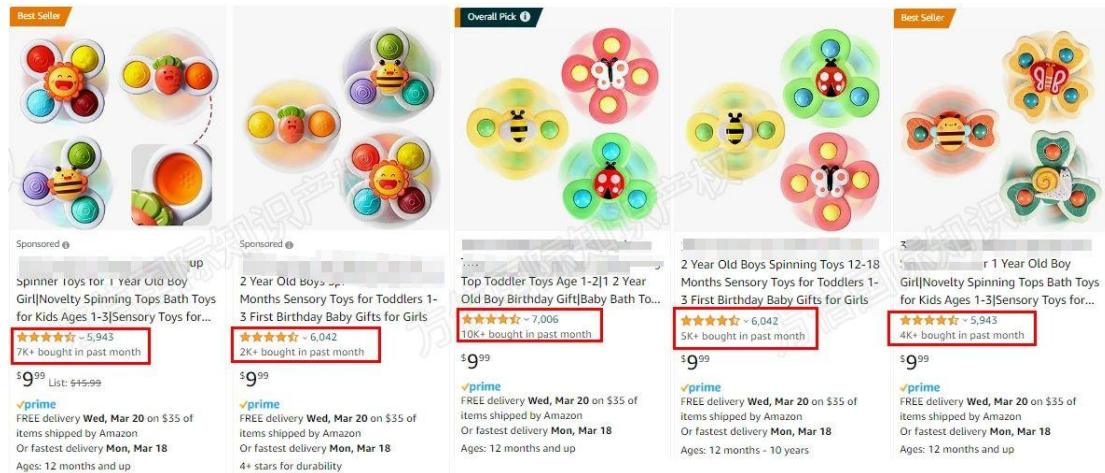

6.2 吸盘旋转玩具----知识产权信息

主要集中在英国和欧盟外观专利。欧盟外观专利号：008487201-0001、008487201-0002、009097314-0001；英国外观专利号：6303328、6303329、6303330。

Design number

6303328

Status
Registered

Registration date
12 August 2023

Renewal date
12 August 2028

[Overview](#) [Illustrations](#) [Names and addresses](#) [History](#)

Application date
12 August 2023

Grant date
22 August 2023

Publication date
23 August 2023

Indication of Product

Toy



Classification

Class 21 - GAMES, TOYS, TENTS AND SPORTS GOODS

Sub class 01 - GAMES AND TOYS

Design number

6303329

Status
Registered

Registration date
12 August 2023

Renewal date
12 August 2028

[Overview](#) [Illustrations](#) [Names and addresses](#) [History](#)

Application date
12 August 2023

Grant date
22 August 2023

Publication date
23 August 2023

Indication of Product

Toy



Classification

Class 21 - GAMES, TOYS, TENTS AND SPORTS GOODS

Sub class 01 - GAMES AND TOYS

Design number

6303330

Status
Registered

Registration date
12 August 2023

Renewal date
12 August 2028

Overview

Illustrations

Names and addresses

History

Application date
12 August 2023

Grant date
22 August 2023

Publication date
23 August 2023

Indication of Product

Toy



Classification

Class 21 - GAMES, TOYS, TENTS AND SPORTS GOODS

Sub class 01 - GAMES AND TOYS

7、Barbie 芭比玩偶

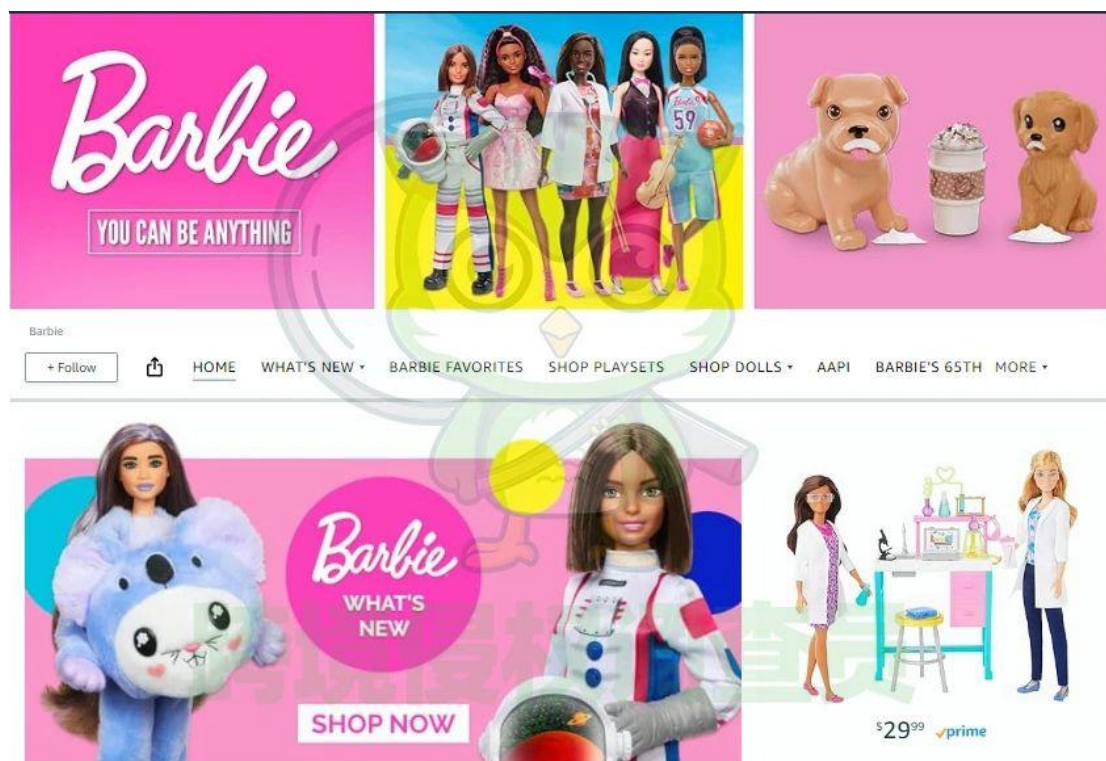

7.1 产品介绍--Barbie 芭比

Mattel, Inc.是一家来自美国的玩具公司，该公司旗下有许多玩具娃娃品牌，包括：Barbie 娃娃、Hot Wheels 小汽车、Fisher-Price 婴儿玩具等。2024 年 5 月发起商标侵权维权，包括 BARBIE 在内的一百多个商标维权，涉及类目多为 28 类户外与玩具大类。



7.2 Barbie 芭比玩偶----知识产权信息

以下关于 Barbie 的部分商标展示：

注册号	商标	所属大类
689055	BARBIE	22
741208	BARBIE	22
5371526	BARBIE SIGNATURE	28
5441651	BARBIE LIVE! IN THE DREAMHOUSE	41
5233292	BARBIE DREAMTOPIA	28
5602185	BARBIE DREAMHOUSE ADVENTURES	28
3083593	BARBIE COLLECTOR	28, 41
6719769	BARBIE BIG CITY, BIG DREAMS	28
4720463	BARBIE AND THE NUTCRACKER	28
726935	KEN	22
3210590	BABY DOCTOR	28
3319393	BFMC	28
6629906	CHRISTIE	28
5618951	MYTHICAL MUSE	28
2150392		35, 42
3493061		25
6290394		28

目前在亚马逊上仍有众多链接涉及这些商标



Barbie Gym sories, Playset with Blonde Fashion Doll, C...
 ★★★★★ ~ 245
 2K+ bought in past month
 \$29⁴⁸
 ✓prime



Barbie It ll & Accessories, Camping Playset with...
 ★★★★★ ~ 2,220
 1K+ bought in past month
 \$11⁹⁷ List: \$16.99
 ✓prime



Barbie Sign ll (12-inch, Brunette Hair in Silver...
 ★★★★★ ~ 1,863
 50+ bought in past month
 Limited time deal
 \$19⁹⁹ List: \$29.99



Barbie Chelsea Playset, 2-Seater Aircraft with...
 ★★★★★ ~ 112
 1K+ bought in past month
 \$11⁹⁹ List: \$19.99
 ✓prime



Barbie Chelsea Toy Set, Includes Helmet Accessory & Saddle...
 ★★★★★ ~ 97
 1K+ bought in past month
 \$10⁹⁹ List: \$16.99
 ✓prime
 FREE delivery Tue, May 14 on \$35 of items



Barbie Fashion Doll & Playset, Ultimate Closet with Barbie Clothes...
 ★★★★★ ~ 2,035
 900+ bought in past month
 \$30⁹⁹ List: \$36.99
 ✓prime
 FREE delivery Tue, May 14 on \$35 of items



Barbie Skipper with Doll, Stroller, Baby Doll & C...
 ★★★★★ ~ 2,771
 700+ bought in past month
 \$21⁴⁸ List: \$22.99
 ✓prime
 FREE delivery Tue, May 14 on \$35 of items



Sponsored
Barbie Gym Playset with Brunette Fashion Doll, C...
 ★★★★★ ~ 245
 1K+ bought in past month
 \$29⁴⁸
 ✓prime

8、可重复使用水球---Dongguan Saienchuangke Technology Co., Ltd.

8.1 产品介绍--可重复使用水球

案件原告 Dongguan Saienchuangke Technology Co., Ltd.是国人卖家，主要生产销售水球产品；该产品季节性较强，常见用于夏天打水仗或者在水中玩耍，这款产品可以重复使用，更具环保意义。



在亚马逊，搜索“Reusable Water Balloons”出现很像相似度高的水球产品在卖。

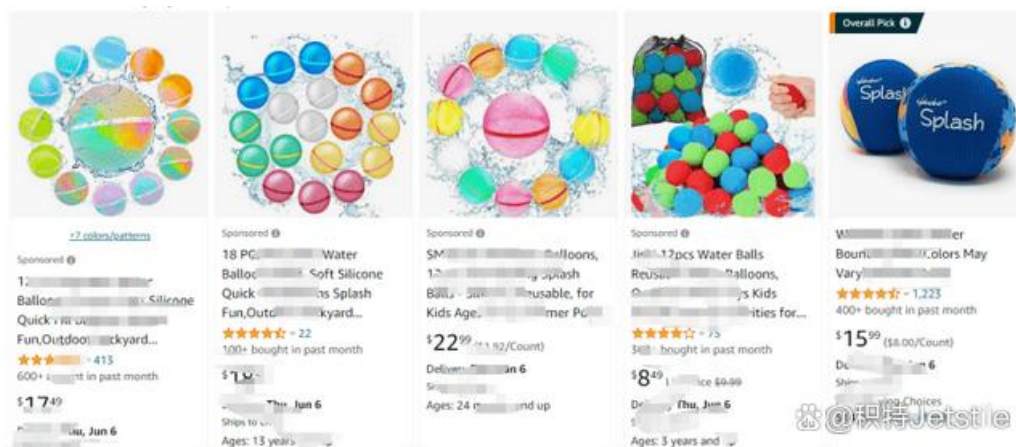

8.2 可重复使用水球---知识产权信息

目前案件原告尚未向法院提出 TRO 动议

编号	日期	描述
10	05/23/2024	Corporate Disclosure Statement by Dongguan Saienchuangke Technology Co., Ltd., identifying Corporate Parent Huizhou Aosai Technology Co., Ltd for Dongguan Saienchuangke Technology Co., Ltd.
	05/23/2024	SYSTEM ENTRY - Docket Entry 7 [motion] restricted/sealed until further notice. (1119131)
9	05/22/2024	Clerk's Notice to Filer re 5 Certificate of Other Affiliates/Corporate Disclosure Statement. Other Affiliates/Corporate Parents Not Entered; ERROR - The Filer failed to enter all Other Affiliates/Corporate Parents from the Certificate of Other Affiliates/Corporate Disclosure Statement. Filer is instructed to refile their Certificate of Other Affiliates/Corporate Disclosure Statement and enter the missing Other Affiliates/Corp Parents. Note - Other Affiliates/Corporate Parents do not appear on the docket sheet.
8	05/23/2024	Ex Parte MOTION for Alternate service by Dongguan Saienchuangke Technology Co., Ltd. 附件： 1. Decl. of Palmer

🐞@积特Jetstile



(12) **United States Design Patent** (10) **Patent No.:** **US D1,026,139 S**
Chen et al. (45) **Date of Patent:** ** **May 7, 2024**

(54) **WATER BALL**

(71) Applicant: **Dongguan Saienchuangke Technology Co., Ltd.**, Dongguan (CN)
 (72) Inventors: **Yunfeng Chen**, Dongguan (CN); **Lixiang Liao**, Dongguan (CN)
 (73) Assignee: **DONGGUAN SAIENCHUANGKE TECHNOLOGY CO., LTD.**, Dongguan (CN)

(**) Term: **15 Years**

(21) Appl. No.: **29/777,659**

(22) Filed: **Apr. 7, 2021**

Foreign Application Priority Data

Dec. 25, 2020 (CN) 202030804483.7
 Feb. 7, 2021 (CN) 202130092836.X

(51) **LOC (14) Cl.** **21-02**

(52) **U.S. Cl.** **D21/713**
 USPC

(58) **Field of Classification Search**

USPC D21/398, 572, 576, 597, 599, 600, 601, D21/616, 622, 698, 781, 707, 712, 713, D21/300, 310, 311, 314, 315; D6/552; D28/76, 78, 82, 88
 CPC A63B 2208/12; A63B 2225/605; A63B 67/007; A63B 69/12; A63B 31/00; A63B 2208/03; A63B 5/10; A63B 63/083; A63B 19/04; A63B 63/08; A63B 39/06; A63B (Continued)

(56) **References Cited**

U.S. PATENT DOCUMENTS

309,032 A * 12/1884 De Ledochowski B63C 9/08 441/89
 503,387 A * 8/1893 Schofield 473/576 (Continued)

FOREIGN PATENT DOCUMENTS

EM 009089014-0001 * 7/2022
 EM 009141773-0001 * 8/2022
 GB 6232828 * 10/2022

OTHER PUBLICATIONS

Tlifimom Store Reusable Water balloons, amazon.com, customer review oldest date Jun. 7, 2022 [online], [site visited Jan. 4, 2023], Available from internet, URL: <https://www.amazon.com/Reusable-balloons-Outdoor-Activities-Sealing/dp/B09ZDQW1PV> (Year: 2022).
 (Continued)

Primary Examiner — Michael C Stout
Assistant Examiner — Thanh Luu Wong
 (74) *Attorney, Agent, or Firm* — Rimon PC

(57) **CLAIM**

I claim the ornamental design for a water ball, as shown and described.

DESCRIPTION

FIG. 1 is a first perspective view of a water ball in a closed state in accordance with my new design, wherein the water ball can hold water therein when the water ball is played; FIG. 2 is a second perspective view of the water ball of FIG. 1;
 FIG. 3 is a front view of the water ball of FIG. 1;
 FIG. 4 is a rear view of the water ball of FIG. 1;
 FIG. 5 is a left side view of the water ball of FIG. 1;
 FIG. 6 is a right side view of the water ball of FIG. 1;
 FIG. 7 is a top view of the water ball of FIG. 1;
 FIG. 8 is a bottom view of the water ball of FIG. 1; and, FIG. 9 is a perspective view of the water ball of FIG. 1 in an open state.
 The broken lines shown in the drawings depict portions of the water ball that form no part of the claimed design.

1 Claim, 9 Drawing Sheets

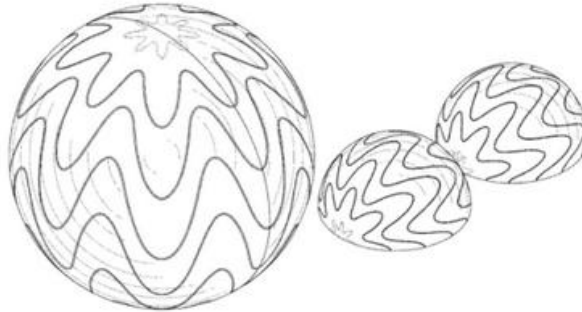

特@积特Jetstyle

9、插画作品涉及到的知识产权侵权风险

9.1 作品信息--Elizabeth Mazur 马祖尔版权画

原告 Elizabeth Mazur 是一位来自多伦多的艺术家，她主要使用钢笔和墨水进行创作，通过视觉艺术、诗歌、壁画和表演来探索自然之美



涉及到的两张版权图维权





9.2 作品信息--Joel robinson 涂鸦插画

joel Robinson 是来自美国的一位服装设计师，经常在 Threadless 上传自己的作品而被网友熟知，其插画风格可爱，主要以动物为主。2024 年 2 月,Joel robinson 涂鸦插画发起了版权维权，维权的图片共有 17 张



图源：亚马逊



9.3 作品信息--Dona Gelsinger 圣诞冬日系列画作

Sriplaw, P.A.律所代理 Dona Gelsinger 圣诞冬日系列画作发起版权维权，目前案件已经成功申请 TRO 禁令，将于 2024 年 6 月 5 日举行首次禁止听证会，

Dona Gelsinger 是一位来自美国的艺术家，她的画作往往以圣诞和冬日为主题，创作多幅精美的插画、画作等；画作中所展示的场景是温馨、祥和的冬日；她的创作风格的独特，充满了艺术感召力。



目前案件已经成功申请 TRO 禁令，将于 2024 年 6 月 5 日举行首次禁止听证会。

#	Date	Description
20	05/24/2024	SUMMONS (Affidavit) Returned Executed on [1] Complaint with a 21 day response/answer filing deadline pursuant to Fed. R. Civ. P. 12 by MNO. The Individuals, Partnerships and Unincorporated Associations Identified on Schedule A served on 5/23/2024, response/answer due 6/13/2024.
19	05/24/2024	Clerk's Notice to Filer re 18 Certificate of Service.Wrong Event Selected; ERROR - The filer selected the wrong event. The correct event is Summons (Affidavit) Returned Executed; CORRECTIVE ACTION REQUIRED WITHIN 3 DAYS - Filer must refile the document using the correct event.
18	05/23/2024	CERTIFICATE OF SERVICE by MNO re [14] Order on Ex Parte Motion
17	05/21/2024	ORDER granting 16 Motion to Continue Hearing on Motion for Preliminary Injunction and Extend TRO. Preliminary Injunction Hearing set for 6/5/2024 11:30 AM before Judge Roy K. Altman. Responses due by 6/3/2024. Replies due by 6/4/2024. Signed by Judge Roy K. Altman on 5/20/2024. See attached document for full details.
16	05/20/2024	MOTION to Continue Hearing on Motion for Preliminary Injunction and Extend Temporary Restraining Order for Fourteen Days by MNO. Responses due by 6/3/2024.
		1 Attachment ▼
15	05/16/2024	NOTICE OF CONVENTIONAL FILING by MNO
		1 Attachment ▼
14	05/09/2024	ORDER Authorizing Alternate Service of Process: granting 11 Ex Parte Motion for Order Authorizing Alternate Service of Process on Defendants pursuant to Federal Rule of Civil Procedure 4(f)(3). Signed by Judge Roy K. Altman on 5/9/2024. See attached document for full details.

©@积特Jetstle

被告名单:

34	Amazon	KAXA	AKE2UY94EOYM5	B08L...	42	Amazon	MyLotto	A5E579VNBHE5M	B0C...
35	Amazon	PANYAYUN	AFVBAJL4ISEM4	B09N...	43	Amazon	Objica	A249SAZLRLXU	B07Y...
36	Amazon	idea art	A3800XQ199FT5K	B0C...	44	Amazon	Parfo Trade	AVCJHNSCTET	B07H...
37	Amazon	LIN DAN poster shop	APAOPBYT096BP	B0C...	45	Amazon	POUKE	A15QX-PYLAXCM	B08L...
38	Amazon	linsj art	A1TNV9GGH4C945	B0C...	46	Amazon	ShiJianZuoGuanShangMao	A3A8FJH7739N8G	B08F...
39	Amazon	jiziciti	A3V2PTPKR091V3	B0B...	47	Amazon	shantat	A5A4U5BRLCDG	B0C...
40	Amazon	LuWaBaiHuo	A2LRRJUT96N19	B09K...	48	Amazon	ritmon	A2GPKR1F9GSH74	B089...
41	Amazon	MOJLU	AV39CBGESNLSB	B07M...	49	Amazon	Sansimon	A2T2RZSHNUKOM	B08L...
					50	Amazon	Sufu5H	A3U2FPMKVJZG	B09J...
					51	Amazon	TERALS-56	A1LHX3AC34842	B0C...
					52	Amazon	Tongmaoshangmao	A3HUSX1FW7	B08J...
					53	Amazon	UcellStore	A320MCG25KW09	B095...
					54	Amazon	JIANXU-GANGMAITOU	A00QC2HCWRLL	B0C...
					55	Amazon	WYNGKE	XTEWCY137AVXR	B0C...

56	Amazon	WJZ ART	A2TB9H1QBILQF6	B0CG...
57	Amazon	woyuanxinju	A31P6SHXRAPTQ8	B0BC...
58	Amazon	YANGPENGXIAN ART	A5X3U2D6AJ9NZ	B0CN...
59	Amazon	Yiwu Xinyan Trading Co., Ltd.	A2OLKF8SRXJ8RK	B0B6R...
60	Amazon	YXXCM	A3NAFGGOWQR5N8	B0CGI...
61	Amazon	zheng saimeng 677	A1QMOCE45J4LRA	B0CKJ...
62	Amazon	九江凡凤明商贸有限公司	A299H8F9Z9HRNL	B0CM...
63	Amazon	沐云	A28T46H2GOXYLW	B07S...

9.4 MOLANG 萌浪兔版权商标维权

Millimages S.A 是一家位于法国巴黎的动画制作公司，该公司以高质量的动画片而闻名。Molang 和 Piu Piu 的故事就是该公司旗下的动画故事，深受观众喜爱。该公司于 2024 年 2 月 27 日起诉一家卖家商标侵权，案件号为 24-cv-01614。

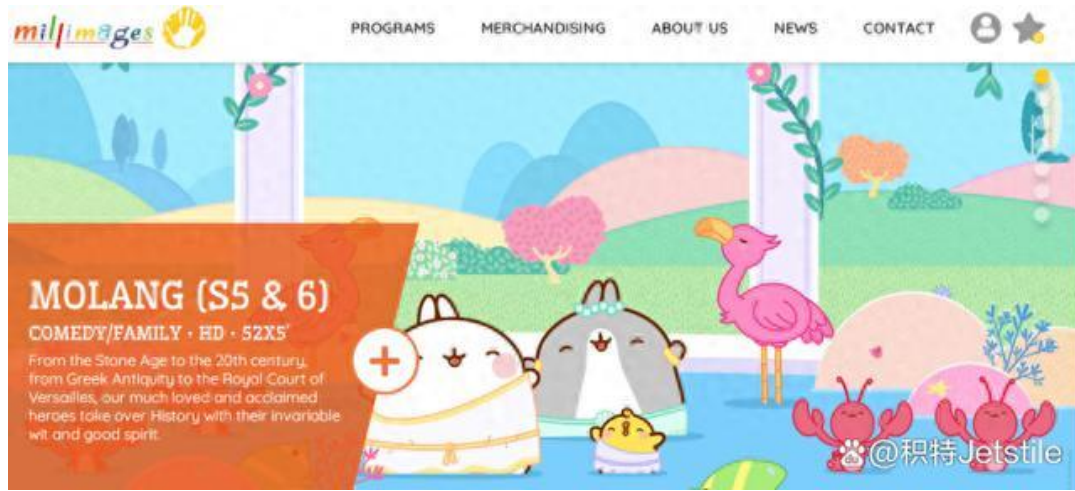

商标侵权具体信息



版权侵权具体信息：

版权号	Copyright Title
TX0008540345	<i>Molang: Butterfly Chase.</i>
TX0008660600	<i>MOLANG: Dress Up! Mix & Match.</i>
TX0008542698	<i>MOLANG: Loves.</i>
TX0008586339	<i>Molang: Molang and Piu Piu.</i>
TX0008613276	<i>MOLANG: Spooky Halloween.</i>
TX0008679413	<i>MOLANG: The Book of Happy.</i>

@积特Jetstyle

10. 亚马逊等跨境电商平台临时禁止令所关注的一些玩具相关产品专利信息

在 4 月下证的美国外观专利中，家居用品和玩具类居多，售卖这些产品的卖家面临 TRO 的风险往往比较高！要密切关注这些新专利并采取适当的规避措施。

主要集中在以下外观专利信息：

Pet toy 宠物玩具：US D1,024,459 S、Toy crane 娃娃机：US D1,024,196 S
Crab toy 螃蟹玩具：US D1,024,224 S、water toy 水上玩具：US D1,024,221 S、Plush toy 毛绒玩具：US D1,024,226 S、Toy lobster 龙虾玩具：US D1,023,173 S、Toy lobster 龙虾玩具：US D1,023,173 S、Toy rocket 火箭玩具：US D1,023,165 S、Educational toy 益智玩具：US D1,023,194 S



US0D1024224S

(12) **United States Design Patent** (10) **Patent No.:** **US D1,024,224 S**
Lin (45) **Date of Patent:** **** Apr. 23, 2024**

(54) **CRAB TOY**
(71) Applicant: **Xixiao Lin**, Shantou (CN)
(72) Inventor: **Xixiao Lin**, Shantou (CN)

(**) Term: **15 Years**
(21) Appl. No.: **29/792,192**

(22) Filed: **Mar. 10, 2022**
(51) **LOC (14) Cl.** **21-02**
(52) **U.S. Cl.** **D21/597**
(58) **Field of Classification Search**
USPC D21/401, 402, 398, 473, 483, 599, 597,
D21/585, 576; D11/158; D9/606
CPC A63H 33/28; A63H 33/00; A63H 29/22;
A63H 23/10; A63H 3/26; A63J 5/025
See application file for complete search history.

(56) **References Cited**
U.S. PATENT DOCUMENTS
D515,567 S * 2/2006 Tsao D14/371
D557,358 S * 12/2007 Boutin D21/597
D599,221 S * 9/2009 Bialek-Wester D10/15
D671,601 S * 11/2012 Hornsby D21/585
D672,409 S * 12/2012 Hornsby D21/585
D672,826 S * 12/2012 Hornsby D21/585
D686,608 S * 7/2013 Yueh D14/250
D733,224 S * 6/2015 White D21/597
D765,302 S * 8/2016 Johnson D26/98

D960,311 S * 8/2022 Chen D23/214
D960,312 S * 8/2022 Chen D23/214
D1,006,135 S * 11/2023 Xie D21/597

OTHER PUBLICATIONS

Deejoy Crab Bubble Bath Maker. Date First Available: Apr. 26, 2022. Retrieved from internet: <https://www.amazon.sg/Deejoy-Bathtub-Bubbles-Childrens-Sing-Along/dp/B09YV5JTWY/> [site visited Dec. 8, 2023] (Year: 2022).
Crab Bath Bubble Maker. Date First Available: Jul. 16, 2023. Retrieved from internet: <https://www.amazon.ca/dp/B0CB3HYTLR/> [site visited Dec. 8, 2023] (Year: 2023).*

* cited by examiner

Primary Examiner — W. A. Teddy Falloway
Assistant Examiner — Yuan Yuan
(74) *Attorney, Agent, or Firm* — Jeenam Park

(57) **CLAIM**
The ornamental design for a crab toy, as shown and described.

DESCRIPTION

FIG. 1 is a perspective view of a crab toy showing my new design;
FIG. 2 is a front elevational view thereof;
FIG. 3 is a rear elevational view thereof;
FIG. 4 is a left side elevational view thereof;
FIG. 5 is a right side elevational view thereof;
FIG. 6 is a top plan view thereof; and,
FIG. 7 is a bottom plan view thereof.

1 Claim, 7 Drawing Sheets

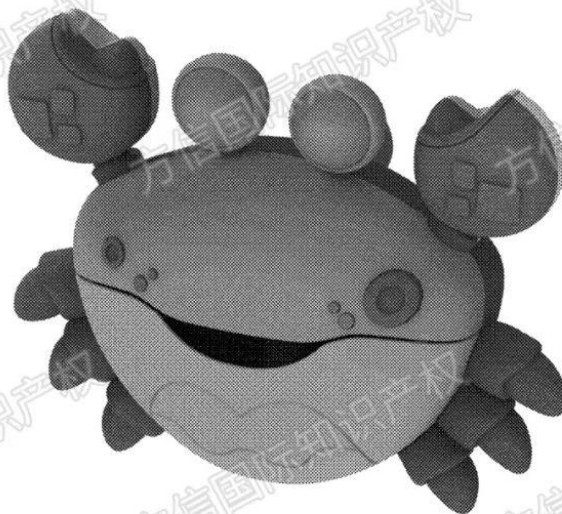



US0D1024226S

(12) **United States Design Patent** (16) **Patent No.:** **US D1,024,226 S**
Wu (45) **Date of Patent:** **** Apr. 23, 2024**

(54) **PLUSH TOY**

(71) Applicant: **Guangzhou Mohuan Xingkong Electronic Commerce Co., Ltd.,**
Guangzhou (CN)

(72) Inventor: **Yifeng Wu, Guangzhou (CN)**

(73) Assignee: **Guangzhou Mohuan Xingkong Electronic Commerce Co., Ltd.,**
Guangzhou (CN)

(**) Term: **15 Years**

(21) Appl. No.: **29/839,852**

(22) Filed: **May 24, 2022**

(51) **LOC (14) Cl.** **21-01**

(52) **U.S. Cl.**
USPC **D21/620**

(58) **Field of Classification Search**
USPC D21/303, 401, 576-578, 584-585,
D21/587-589, 591-593, 601, 604,
D21/621-625, 630-631, 639, 658-661,
D32/21
CPC A63H 3/003; A63H 3/005; A63H 3/006;
A63H 3/36; A63H 3/02; A63H 3/06;
A63H 3/28; A63H 3/00; A63H 33/00;
A63H 33/22; A63H 33/26; A63H 33/28;
A63H 23/10; A63H 11/00; A63H 7/00;
A63H 5/00; A63H 1/00
See application file for complete search history.

(56) **References Cited**

U.S. PATENT DOCUMENTS

D348,172 S * 6 1994 Keller D6/601
D408,197 S * 4 1999 Bear D21/620
D409,037 S * 5 1999 Bear D21/650
D672,995 S * 12 2012 Diaz D21/611
D680,787 S * 4 2013 Diaz D21/620
D793,757 S * 8 2017 George, II D6/351
D835,924 S * 12 2018 Moss D6/598

D855,712 S * 8 2019 Buonocore D21/620
D857,121 S * 8 2019 Buonocore D21/617
D882,887 S * 4 2020 Seadler D21/615
D972,193 S * 12 2022 Fan D21/617
(Continued)

FOREIGN PATENT DOCUMENTS

CN 305829255 * 6/2020
CN 306770028 * 8/2021
(Continued)

OTHER PUBLICATIONS

Amazon.com, Aurora Enchanting Tasty Peach Green Tea, announced Jun. 19, 2021 [online]. Available from internet, URL:<https://www.amazon.com/Aurora-Green-Meowchi-Tasty-inches/dp/B084RDY4X6/> (Year: 2021).*

(Continued)

Primary Examiner — Lauren D McVey

Assistant Examiner — Elisa Maria Pujals

(74) *Attorney, Agent, or Firm* — Georgi Korobanov

(57) **CLAIM**

The ornamental design for a plush toy, as shown and described.

DESCRIPTION

FIG. 1 is a perspective view of a plush toy, showing my new design;
FIG. 2 is another perspective view thereof;
FIG. 3 is a front view thereof;
FIG. 4 is a rear view thereof;
FIG. 5 is a left side view thereof;
FIG. 6 is a right side view thereof;
FIG. 7 is a top plan view thereof;
FIG. 8 is a bottom plan view thereof; and,
FIG. 9 is a perspective view thereof shown in an alternate state.

1 Claim, 9 Drawing Sheets

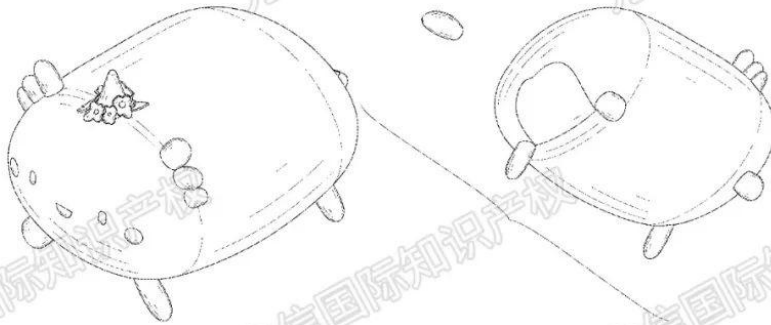



US0D1024459S

(12) **United States Design Patent** (10) **Patent No.: US D1,024,459 S**
Yin (45) **Date of Patent: ** Apr. 23, 2024**

(54) **PET TOY** D977,755 S * 2/2023 Nguyen D30/160
D1,010,247 S * 1/2024 Wang D30/160
2022/0088443 A1* 3/2022 Booz A63B 43/00

(71) Applicant: **Jinhua Yinuo Toys Co., Ltd.**, Jinhua (CN)

(72) Inventor: **Guishan Yin**, Ji'an (CN)

(73) Assignee: **Jinhua Yinuo Toys Co., Ltd.**, Jinhua (CN)

(**) Term: **15 Years**

(21) Appl. No.: **29/840,256**

(22) Filed: **May 27, 2022**

(51) **LOC (14) Cl.** **30-12**

(52) **U.S. Cl.**

USPC **D30/160; D21/713**

(58) **Field of Classification Search**

USPC D30/160; D21/373; 398; 662; 707; 708; D21/709; 712; 713; 714

CPC A01K 15/02; A01K 15/025; A01K 15/026; A63B 2208/12; A63B 2208/14; A63B 37/0004; A63B 37/0005; A63B 37/0011; A63B 39/00; A63B 2039/003; A63B 41/00; A63B 43/00

See application file for complete search history.

(56) **References Cited**

U.S. PATENT DOCUMENTS

D396,904 S * 8/1998 Leu D21/713
D540,496 S * 4/2007 Axelrod D30/160
D840,116 S * 2/2019 Steinkraus D30/160
D873,508 S * 1/2020 Loibl D30/160
D912,171 S * 3/2021 von Heland D21/713
D948,139 S * 4/2022 Khubani D30/160
D955,069 S * 6/2022 Xu D30/160
D976,332 S * 1/2023 Wu D30/160

FOREIGN PATENT DOCUMENTS

CN 307078187 * 1/2022

OTHER PUBLICATIONS

Tauchgoe Interactive Giggle Ball for Large Dog Tough Squeaky Wobble Wag for Medium Small Peppy Dog Pet Toy (Spiky Circle, L(5.5Inch)); posted Nov. 8, 2021, retrieved Aug. 28, 2023 [online]. URL: <https://www.amazon.com.au/TAUCHGOE-Interactive-Giggle-Squeaky-5-5Inch/dp/B09L87HBRW?th=1> (Year: 2021).
Tauchgoe Interactive Giggle Ball for Large Dog Tough Squeaky Wobble Wag for Medium Small Peppy Dog Pet Toy (Spiky Wave, L(5.5Inch)); posted Nov. 8, 2021, retrieved Aug. 28, 2023 [online]. URL: <https://www.amazon.com.au/TAUCHGOE-Interactive-Giggle-Squeaky-5-5Inch/dp/B09L868BXC?th=1> (Year: 2021).*

* cited by examiner

Primary Examiner — Samantha Wood

Assistant Examiner — Emily A Caven

(74) *Attorney, Agent, or Firm* — Jose Cherson Weissbrot

(57) **CLAIM**

The ornamental design for a pet toy, as shown and described.

DESCRIPTION

FIG. 1 is a first perspective view of a pet toy showing my new design;

FIG. 2 is a second perspective view thereof;

FIG. 3 is a front view thereof;

FIG. 4 is a back view thereof;

FIG. 5 is a left side view thereof;

FIG. 6 is a right side view thereof;

FIG. 7 is a top view thereof; and,

FIG. 8 is a bottom view thereof.

The broken lines shown in the drawings depict portions of the pet toy that form no part of the claimed design.

1 Claim, 8 Drawing Sheets





USOD1023173S

(12) **United States Design Patent** (10) **Patent No.:** **US D1,023,173 S**
Gao (45) **Date of Patent:** **** Apr. 16, 2024**

(54) **TOY LOBSTER**
(71) Applicant: **Shiyong Gao**, Guangdong (CN)
(72) Inventor: **Shiyong Gao**, Guangdong (CN)

(**) Term: **15 Years**
(21) Appl. No.: **29/916,300**

(22) Filed: **Nov. 9, 2023**
(51) **LOC (14) Cl.** **21-01**
(52) **U.S. Cl.**
USPC **D21/597**

(58) **Field of Classification Search**
USPC D21/519, 521, 572, 575-576, 597-599,
D21/655, 615-616, 714, 803, 808;
D26/24, 93-94, 98
CPC A63H 23/00; A63H 23/10; A63H 23/16;
A63H 23/12; A63H 7/00; A63H 7/06;
A63H 3/26
See application file for complete search history.

(56) **References Cited**

U.S. PATENT DOCUMENTS

2,218,280 A * 10/1940 Deering A01K 85/16
43/42.43
D316,300 S * 4/1991 Hedges D11/158
D411,967 S * 7/1999 Philipson D11/86
D465,544 S * 11/2002 Brinkman D22/132
D483,773 S * 12/2003 Lovegreen D21/597
7,272,910 B2 * 9/2007 Mell A01K 85/00
43/42.26

(Continued)

FOREIGN PATENT DOCUMENTS

CN 305949448 * 7/2020
CN 307378553 * 5/2022

(Continued)

OTHER PUBLICATIONS

Little Tikes Catch Me Crabbie Lil Ocean Explorers Interactive
Musical Crab Works _ eBay, site visited Feb. 2, 2024 [online].

Available from internet, URL: <https://www.ebay.com/itm/225710956102?> (Year: 2024).
(Continued)

Primary Examiner — Lauren D McVey
Assistant Examiner — Elisa M Pujals
(74) *Attorney, Agent, or Firm* — Hawaii Patent Services;
Nathaniel K. Fedde; Kenton N. Fedde

(57) **CLAIM**

The ornamental design for a toy lobster, as shown and described.

DESCRIPTION

FIG. 1 is a front, top perspective view of a toy lobster, showing my new design;
FIG. 2 is a rear, bottom perspective view thereof;
FIG. 3 is a rear, bottom perspective view of the toy lobster in another angle;
FIG. 4 is a front elevational view thereof;
FIG. 5 is a rear elevational view thereof;
FIG. 6 is a left side view thereof;
FIG. 7 is a right side view thereof;
FIG. 8 is a top plan view thereof;
FIG. 9 is a bottom plan view thereof; and,
FIG. 10 is an enlarged view of detail 10 in FIG. 9.

The dashed broken lines in the figures are for the purposes of illustrating portions of the toy lobster that form no part of the claimed design.

The dashed broken lines immediately adjacent to the bottom edge area in the FIG. 2, FIG. 3 and FIG. 9 are for the purposes of illustrating the boundaries of the toy lobster that form no part of the claimed design, and the portions of the design within the dashed broken lines boundary form no part of the claimed design.

The dash-dot-dash broken lines are for notating enlarged views and form no part of the claimed design.

1 Claim, 10 Drawing Sheets





USOD10231655

(12) **United States Design Patent** (10) **Patent No.:** **US D1,023,165 S**
Chen (45) **Date of Patent:** **** Apr. 16, 2024**

(54) **TOY ROCKET**
(71) Applicant: **Yue Chen**, Shantou (CN)
(72) Inventor: **Yue Chen**, Shantou (CN)
(**) Term: **15 Years**
(21) Appl. No.: **29/827,198**
(22) Filed: **Feb. 17, 2022**

(30) **Foreign Application Priority Data**
Dec. 16, 2021 (CN) 202130831998.0
Dec. 16, 2021 (CN) 202130832000.9
Dec. 16, 2021 (CN) 202130832054.5
(51) **LOC (14) Cl.** **21-01**
(52) **U.S. Cl.**
USPC **D21/452**
(58) **Field of Classification Search**
USPC D21/452, 447, 430, 436, 453; D12/16.1,
D12/319, 331, 14, 320, 326, 328, 333,
D12/337, 434, 435
CPC B64C 23/00; B64C 29/0008
See application file for complete search history.

(56) **References Cited**
U.S. PATENT DOCUMENTS
D888,162 S * 6/2020 Fang D21/452
D970,633 S * 11/2022 Zhang D21/452
D982,093 S * 3/2023 Zhang D21/452
D994,334 S * 8/2023 Qu D3/901

OTHER PUBLICATIONS
"Green Toys Rocket, Red/Blue—4 Piece Pretend Play, Motor Skills, Kids Toy Vehicle Playset" amazon.com, post Published Unavailable. Retrieved Sep. 13, 2023. Available online at URL:https://www.amazon.com/Green-Toys-Astronauts-Vehicle-Playset/dp/B00BPRLGVE?th=1 (Year: 2023).*

"Temi Space Shuttle Toys Rocket Toys for 3 4 5 6 7 8 9 Years Old Kids Science Educational Toys 5-in-1" amazon.com, post Published unavailable. Retrieved Sep. 13, 2023. Available online at URL:https://www.amazon.com/TEMI-Educational-Aerospace-Astronauts-Projection/dp/B09ZNYN6Z3/ref=sr_1_25?crid= (Year: 2023).*

* cited by examiner
Primary Examiner — Christian P. McLean
Assistant Examiner — Jessica Lynn Devilbiss
(74) *Attorney, Agent, or Firm* — Jose Cherson Weissbrot

(57) **CLAIM**
The ornamental design for a toy rocket, as shown and described.

DESCRIPTION
FIG. 1 is a first perspective view of a toy rocket showing my new design;
FIG. 2 is a second perspective view thereof;
FIG. 3 is a front view thereof;
FIG. 4 is a back view thereof;
FIG. 5 is a left side view thereof;
FIG. 6 is a right side view thereof;
FIG. 7 is a top view thereof;
FIG. 8 is a bottom view thereof;
FIG. 9 is an enlarged view of the selected portion 9 in FIG. 1;
FIG. 10 is an enlarged view of the selected portion 10 in FIG. 1; and,
FIG. 11 is an enlarged view of the selected portion 11 in FIG. 2.
The broken lines shown in the drawings depict portions of the toy rocket that form no part of the claimed design. The dot-dash broken lines illustrate the periphery of the enlarged views of the toy rocket and form no part of the claimed design.

1 Claim, 11 Drawing Sheets

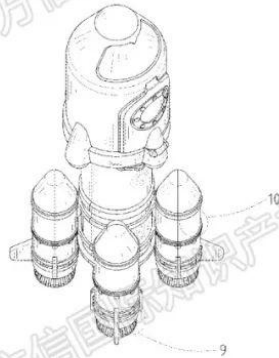



USOD1023194S

(12) **United States Design Patent** (10) Patent No.: **US D1,023,194 S**
Lin (45) Date of Patent: **** Apr. 16, 2024**

(54) **EDUCATIONAL TOY** D952,758 S * 5/2022 Lan D21/468
D1,010,742 S * 1/2024 Zhou D21/456
2018/0015361 A1 * 1/2018 Lee A63F 9/0857

(71) Applicant: **Yangchong Lin, Shantou (CN)**

(72) Inventor: **Yangchong Lin, Shantou (CN)**

(**) Term: **15 Years**

(21) Appl. No.: **29/886,795**

(22) Filed: **Mar. 13, 2023**

(51) **LOC (14) Cl.** **21-01**

(52) **U.S. Cl.** **D21/478; D21/468**

(58) **Field of Classification Search**

USPC D21/498, 478, 479, 499, 300, 398, 468,
D21/455, 456, 713, 714

CPC A63F 9/0826; A63F 9/0865; A63F 9/08;
A63F 9/16; A63F 9/0857; A63F 9/0869;
A63F 2009/165; A63H 33/00

See application file for complete search history.

(56) **References Cited**

U.S. PATENT DOCUMENTS

D267,661 S * 1/1983 Yokoi D21/478

4,382,601 A * 5/1983 Dezsi A63F 9/0811
273/153 S

D269,629 S * 7/1983 Wiggs D21/478

4,553,754 A * 11/1985 Wiggs A63F 9/0857
273/153 S

D336,317 S * 6/1993 Thomson D21/468

D345,397 S * 3/1994 Kamandi D21/468

5,449,175 A * 9/1995 Nagy A63F 9/0857
273/153 S

5,645,278 A * 7/1997 Harris A63F 9/0869
273/153 S

D949,977 S * 4/2022 Lan D21/468

OTHER PUBLICATIONS

Odikaso Rotating Fidget Spinner Toy. Date First Available: Apr. 13, 2021. Retrieved from internet: <https://www.amazon.com.au/ODIKASO-Rotating-Infinity-Unisex-Children-Educational/dp/B092FQH843?th=1> [site visited Jan. 18, 2024] (Year: 2021).*

* cited by examiner

Primary Examiner — W. A. Teddy Falloway

Assistant Examiner — Yuan Yuan

(74) *Attorney, Agent, or Firm* — Daniel M. Cohn;

Howard M. Cohn

(57) **CLAIM**

The ornamental design for an educational toy, as shown and described.

DESCRIPTION

FIG. 1 is a perspective view of an educational toy showing my new design;

FIG. 2 is another perspective view thereof;

FIG. 3 is a front elevational view thereof;

FIG. 4 is a rear elevational view thereof;

FIG. 5 is a left side elevational view thereof;

FIG. 6 is a right side elevational view thereof;

FIG. 7 is a top plan view thereof; and,

FIG. 8 is a bottom plan view thereof.

1 Claim, 8 Drawing Sheets

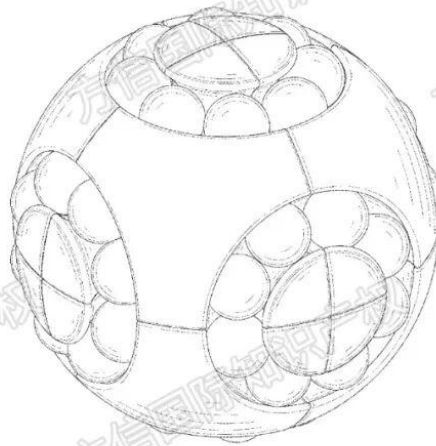



USD1024196S

(12) **United States Design Patent** (10) **Patent No.:** **US D1,024,196 S**
Chen (45) **Date of Patent:** **** Apr. 23, 2024**

(54) **CLAW CRANE GAME MACHINE** D638,479 S * 5/2011 Verstraeten D21/333
8,016,292 B1 * 9/2011 Yang G07F 17/32
(71) Applicant: **Jianchuang Chen, Shantou (CN)** 273/447
8,353,518 B1 * 1/2013 Lai G07F 17/3297
(72) Inventor: **Jianchuang Chen, Shantou (CN)** 273/447
(**) Term: **15 Years** D781,388 S * 3/2017 Lu D21/811
D794,716 S * 8/2017 Wei D21/325
D835,197 S * 12/2018 Inuyama D21/325
D884,075 S * 5/2020 Fukazawa D21/325
(21) Appl. No.: **29/830,970** (Continued)

(22) Filed: **Mar. 16, 2022**
(51) **LOC (14) Cl.** **21-01**
(52) **U.S. Cl.**
USPC **D21/325**
(58) **Field of Classification Search**
USPC D21/324, 325, 811
CPC A63F 9/00; A63F 9/30; A63F 13/08; A63F
3/90; A63F 2250/144; G07F 17/3253
See application file for complete search history.

Primary Examiner — Mehri F Bajoul
(74) *Attorney, Agent, or Firm* — Che-Yang Chen; Law
Office of Michael Chen

(57) **CLAIM**

The ornamental design for a claw crane game machine, as shown and described.

DESCRIPTION

(56) **References Cited**

U.S. PATENT DOCUMENTS

5,397,134 A *	3/1995	Fishman	G07F 17/32
				221/210
5,549,372 A *	8/1996	Lewis	G07F 17/32
				312/265.5
D429,768 S *	8/2000	Smart	D21/325
D433,716 S *	11/2000	Robrahn	D21/325
D438,260 S *	2/2001	Istani	D21/325
6,283,475 B1 *	9/2001	Stubben	A63F 9/30
				273/447
6,899,337 B2 *	5/2005	Fisher	A63F 9/30
				273/447
6,921,076 B1 *	7/2005	Norton	A63F 9/30
				273/447
D516,128 S *	2/2006	Nunokawa	D21/325
D519,568 S *	4/2006	Yao	D21/369
7,080,840 B1 *	7/2006	Chen	A63F 9/30
				273/447
7,604,238 B2 *	10/2009	Verstraeten	A63F 9/30
				273/448
7,637,507 B2 *	12/2009	Peck	A63F 9/30
				273/448

FIG. 1 is a perspective view of first embodiment of the claw crane game machine showing my new design;
FIG. 2 is a front elevational view thereof;
FIG. 3 is a rear elevational view thereof;
FIG. 4 is a left side elevational view thereof;
FIG. 5 is a right side elevational view thereof;
FIG. 6 is a top plan view of thereof;
FIG. 7 is a bottom plan view of thereof;
FIG. 8 is a perspective view of second embodiment of the claw crane game machine showing my new design;
FIG. 9 is a front elevational view thereof;
FIG. 10 is a rear elevational view thereof;
FIG. 11 is a left side elevational view thereof;
FIG. 12 is a right side elevational view thereof;
FIG. 13 is a top plan view of thereof; and,
FIG. 14 is a bottom plan view of thereof.
The broken lines in the drawings depict portions of the claw crane gaming machine that form no part of the claimed design.

1 Claim, 14 Drawing Sheets

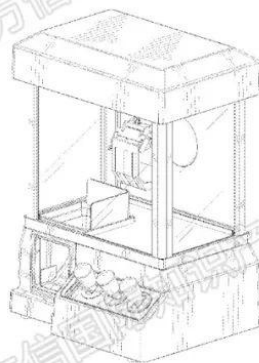



USOD1024221S

(12) **United States Design Patent** (10) **Patent No.:** **US D1,024,221 S**
Chen (45) **Date of Patent:** **** Apr. 23, 2024**

(54) **MONSTER SHAPED WATER TOY**
(71) Applicant: **Bo Chen**, Guangdong (CN)
(72) Inventor: **Bo Chen**, Guangdong (CN)
(73) Assignee: **Shantou P&C Plastic Products Company Limited**, Shantou (CN)
(**) Term: **15 Years**
(21) Appl. No.: **29/835,670**
(22) Filed: **Apr. 21, 2022**
(51) **LOC (14) Cl.** **21-02**
(52) **U.S. Cl.**
USPC **D21/808; D21/572; D21/803; D21/801**
(58) **Field of Classification Search**
USPC D21/570, 572, 575, 542, 301, 436, 447, D21/452, 801, 803, 809
CPC A63H 23/10; A63H 33/28
See application file for complete search history.

(56) **References Cited**
U.S. PATENT DOCUMENTS
4,302,003 A * 11/1981 Hughes A63G 17/00 446/29
D736,335 S * 8/2015 Liberatore D21/803
D853,510 S * 7/2019 Zucchelli D21/597
D853,511 S * 7/2019 Zucchelli D21/599
D853,512 S * 7/2019 Zucchelli D21/599
D853,513 S * 7/2019 Zucchelli D21/602
D853,514 S * 7/2019 Zucchelli D21/597
D957,529 S * 7/2022 Chen D21/401
D957,530 S * 7/2022 Chen D21/401
D958,898 S * 7/2022 Chen D21/401
D958,899 S * 7/2022 Chen D21/401
2002/0102912 A1 * 8/2002 Duval A63H 3/003 446/268
FOREIGN PATENT DOCUMENTS
CN 303440432 * 11/2015
CN 303671089 * 5/2016

OTHER PUBLICATIONS
Amazon Website, Beco Diving Monster, Earliest Available Date: Apr. 9, 2014 [Website Visited Aug. 8, 2023] Available on the Internet URL <https://www.amazon.com/dp/B00B1AIWNO/> (Year: 2014).
Amazon Website, Swimline Animal Dive Sticks, Earliest Available Date: Feb. 24, 2022 [Website Visited Aug. 8, 2023] Available on the Internet URL <https://www.amazon.com/dp/B083JD9NGV/> (Year: 2022).
Amazon Website, SASBSC Diving Sticks, Earliest Comment Date: Jun. 16, 2023 [Website Visited Aug. 8, 2023] Available on the Internet URL <https://www.amazon.com/dp/B0C2CF1QVW/> (Year: 2023).
* cited by examiner
Primary Examiner — S. Bryan Reinholdt, Jr.
Assistant Examiner — James T Tyree
(74) *Attorney, Agent, or Firm* — Minder Law Group; Willy H. Wong

(57) **CLAIM**
The ornamental design for a monster shaped water toy, as shown and described.

DESCRIPTION
FIG. 1 is a front view of a monster shaped water toy showing my new design.
FIG. 2 is a rear view thereof.
FIG. 3 is a left side view thereof.
FIG. 4 is a right side view thereof.
FIG. 5 is a top view thereof; and
FIG. 6 is a bottom view thereof.
The broken lines show portions of the monster shaped water toy that form no part of the claimed design.

1 Claim, 5 Drawing Sheets

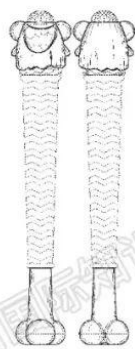



US0D1024197S

(12) **United States Design Patent** (10) **Patent No.:** **US D1,024,197 S**
Qin (45) **Date of Patent:** **** Apr. 23, 2024**

(54) **GAME CONSOLE**
(71) Applicant: **Dongguan Zhixu Silicone Mold Products Co., Ltd.**, Dongguan Guangdong (CN)
(72) Inventor: **Xu Qin**, Luzhou Sichuan (CN)

(**) Term: **15 Years**

(21) Appl. No.: **29/921,198**

(22) Filed: **Dec. 15, 2023**

(51) **LOC (14) Cl.** **21-01**

(52) **U.S. Cl.** **D21/332; D21/468**

(58) **Field of Classification Search**

USPC D21/324, 325, 328, 330, 332, 333, 350;

D14/299, 400, 413, 415, 496, 502, 505,

D14/506; D13/168

CPC A63F 13/24; A63F 9/00; A63F 9/24; A63F

11/00; A63F 13/00; A63F 13/02; A63F

2300/00; G07F 17/00

See application file for complete search history.

(56) **References Cited**

U.S. PATENT DOCUMENTS

D350,373 S *	9/1994	Chow	D21/324
D399,537 S *	10/1998	Chi	D21/324
D557,747 S *	12/2007	Nagano	D21/324
D559,327 S *	1/2008	Luk	D21/324
D613,341 S *	4/2010	Mar	D14/203.7
D646,726 S *	10/2011	Avery	D21/324
D706,358 S *	6/2014	Yamamoto	D21/330
D721,814 S *	1/2015	Creed	D14/218
D793,383 S *	8/2017	Cai	D14/341
D799,598 S *	10/2017	Clark	D21/324
D804,452 S *	12/2017	Parfitt	D14/218
D805,133 S *	12/2017	Sparks	D21/332
D850,444 S *	6/2019	Mullins	D14/344
D922,218 S *	6/2021	Katris	D10/41
D939,635 S *	12/2021	Chen	D21/468
D941,398 S *	1/2022	Zhang	D21/468
D943,026 S *	2/2022	Yu	D21/350

D943,679 S *	2/2022	Huang	D21/468
D947,953 S *	4/2022	Cui	D21/468
D951,353 S *	5/2022	Lv	D21/332
D953,440 S *	5/2022	Li	D21/468
D961,683 S *	8/2022	Schultheis	D21/338
D963,638 S *	9/2022	Chen	D14/341
D969,222 S *	11/2022	Li	D21/360
D976,575 S *	1/2023	He	D21/468
D982,081 S *	3/2023	Ji	D19/113
D982,082 S *	3/2023	Li	D19/113

(Continued)

OTHER PUBLICATIONS

"Pocket Game For Kids, Quick Push Bubble Competitive Game Console". Found online Dec. 15, 2023 at temu.com. Reference dated Mar. 11, 2023. Retrieved from https://www temu.com/pocket-game-for-kids-quick-push-bubble-competitive-game-console-series-creative-decompression-game-console-decompression-puzzle-game-machine-multiple-game-modes-toy-for-kids-adult-g-601099529189472.html?rps=201265&rps=10040&r_pid=14122598677&is_back=1&no_cache_id=k213 Year: 2023).

Primary Examiner — Mehri F Bajjoul

(74) Attorney, Agent, or Firm — Vladimir Postnikov

CLAIM

(57) The ornamental design for a game console, as shown and described.

DESCRIPTION

FIG. 1 is a perspective view of a game console showing the new design;

FIG. 2 is another perspective view thereof;

FIG. 3 is a front elevation view thereof;

FIG. 4 is a back elevation view thereof;

FIG. 5 is a left-side view thereof;

FIG. 6 is a right-side view thereof;

FIG. 7 is a top plan view thereof; and,

FIG. 8 is a bottom plan view thereof.

The broken lines depict portions of the game console that form no part of the claimed design.

1 Claim, 8 Drawing Sheets



免责声明:

本报告提供的资讯为一般性信息,供会员单位查阅参考不取代任何可适用的法律或规章要求

主办: 深圳市玩具行业协会

供稿单位: 深圳市方信知识产权代理有限公司、广州积特知识产权代理事务所

主办及供稿单位将不承担与报告文稿相关的任何赔偿责任。